

PRODUCT DATASHEET

DL COMFORT DN 130 13 W 3CCT IP54 WT

DOWNLIGHT COMFORT | Downlights with adjustable white light colors



Areas of application

- Direct replacement for luminaires with compact fluorescent lamps
- General illumination
- Bathrooms
- Kitchens
- Offices
- Corridors
- Foyers
- Shops
- Stairways

Product benefits

- Three light color in one luminaire: Warm White, Cool White, Daylight White
- Simple installation thanks to integrated driver
- Easy installation with fast connection
- 5 years guarantee

Product features

- Three light colors selectable via slide switch
- Type of protection: IP54
- Connector box with push wire terminal for tool-free connection
- Through wiring possible



TECHNICAL DATA

Electrical data

Nominal wattage	13.00 W
Nominal voltage	100...277 V
Mains frequency	50...60 Hz
Nominal current	140 mA
Inrush current	40 A
Inrush current time T_{h50}	100 μ s
Max. number of luminaires per miniature circuit breaker B16	18
Max. number of luminaires per miniature circuit breaker C10	15
Max. number of luminaires per miniature circuit breaker C16	24
Power factor λ	> 0.90
Total harmonic distortion	< 20 %
Protection class	I
Operating mode	Integrated LED driver

Photometrical data

Luminous flux	1030 lm / 1210 lm / 1110 lm ¹⁾
Luminous efficacy	85 lm/W ²⁾
Color temperature	3000 K / 4000 K / 5700 K
Light color (designation)	Warm White / Cool White / Cool Daylight
Color rendering index Ra	> 80
Standard deviation of color matching	< 5 sdc _m
Luminous intensity	-
Flickering metric (Pst LM)	-
Stroboscope effect metric (SVM)	-
Photobiological safety group acc. to EN62778	RG0
Photobiological safety group acc. to EN62471	RG0
Beam angle	60 °
UGR	< 22

1) Luminous flux dependent on selected color temperature: 1030 lm@3000 K / 1110 lm@5700 K / 1210 lm@4000 K

2) Value at 5700 K, different for other color temperatures

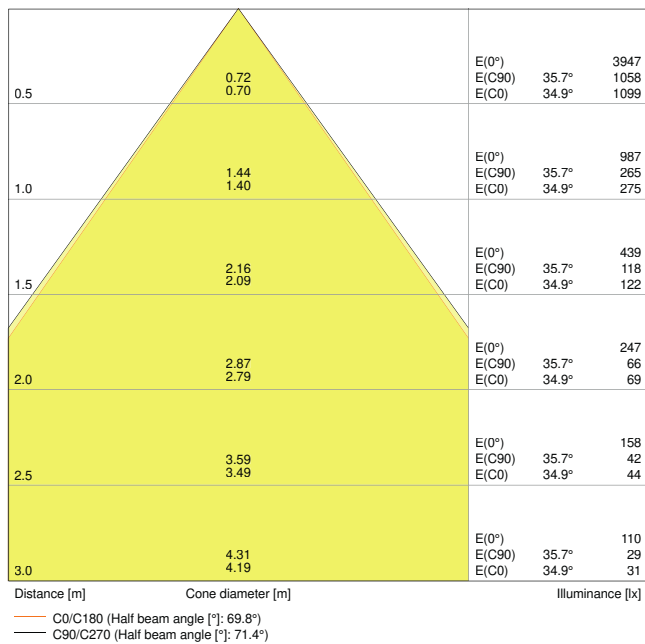

DL COMFORT DN130 13W3CCT 60DEG WT-4000K

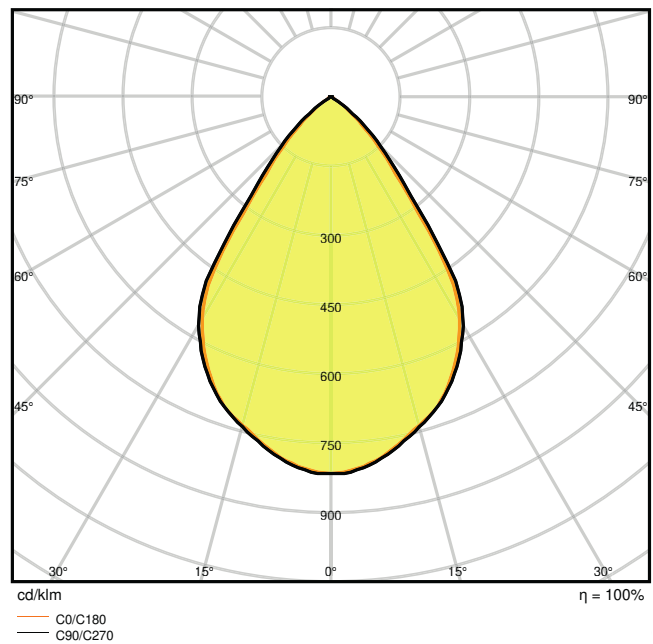

DL COMFORT DN130 13W3CCT 60DEG WT-4000K

Dimensions & Weight

Diameter	145.00 mm
Height	82.00 mm
Product weight	265.00 g

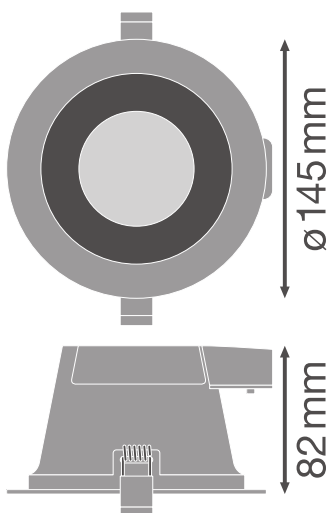

DL COMFORT DN130 13W

Materials & Colors

Product color	White
Housing color	White
Body material	Aluminum
Cover material	Polymethylmethacrylate (PMMA)
Glow Wire Test according to IEC 60695-2-12	650 °C
Mercury content	0.0 mg

Application & Mounting

Ambient temperature range	-20...+45 °C
Type of connection	Screwless terminal, 2-Pole
Type of protection	IP54/IP20
Protection class IK (shock resistance)	IK03
Dimmable	No
Mounting type	Recessed
Mounting location	Ceiling
Application environment	Indoor
Mounting diameter	130 mm
Mounting depth	125 mm
LED module replaceable	Not replaceable
With light source	Yes

Lifespan

Lifespan L70/B50 at 25 °C	50000 h ¹⁾
Lifespan L80/B10 at 25 °C	43000 h ¹⁾
Lifespan L90/B10 at 25 °C	30000 h
Number of switching cycles	50000

¹⁾ t[h]: L70 / B50 @ 25 °C (Ta), t[h]: L80 / B10 @ 25 °C (Ta), t[h]: L90 / B10 @ 25 °C (Ta)















Certificates & Standards

Standards	CE / CB / ENEC / TÜV SÜD
Luminaire with limited surface temperature, "D sign"	No
Ball shot safe	No

Additional product data

Number of illuminants	Not relevant
Added function	MULTI SELECT

DOWNLOAD DATA

Documents and certificates		Document name
	User Instruction	DL COMFORT 3CCT
	Addon Technical Information	LSI_DL COMFORT 3 CCT
	Legal information	LI DL COMFORT
	Declarations of conformity	Attestation-of-Conformity DOWNLIGHT Comfort TÜV
	Declarations of conformity	EU Declaration of Conformity DOWNLIGHT Comfort LEDV
	Declarations Of Conformity UKCA	DOWNLIGHT COMFORT / DL UGR19
Photometric and lighting design files		Document name
	IES file (IES)	DOWNLIGHT COMFORT 13W 3CCT
	LDT file (Eulumdat)	DL COMFORT DN130 13W3CCT 60DEG WT-4000K
	ULD file (DIALux)	DL COMFORT DN130
	ROLF file (RELUX)	DL COMFORT DN130
	UGR file (UGR table)	DL COMFORT DN130 13W3CCT 60DEG WT-4000K
	LDC typ cone	DL COMFORT DN130 13W3CCT 60DEG WT-4000K
	LDC typ polar	DL COMFORT DN130 13W3CCT 60DEG WT-4000K
CAD/BIM files		Document name
	CAD_STEP_3D	DL COMFORT DN130

Tender texts	Document name
 Tender documents	DOWNLIGHT COMFORT 130 13 W 3CCT IP54 WT-EN

LOGISTICAL DATA

Product code	Packaging unit (Pieces/Unit)	Dimensions (length x width x height)	Gross weight	Volume
4058075104068	Folding box 1	170 mm x 170 mm x 125 mm	326.00 g	3.61 dm ³
4058075104075	Shipping box 8	360 mm x 360 mm x 270 mm	3640.00 g	34.99 dm ³

The mentioned product code describes the smallest quantity unit which can be ordered. One shipping unit can contain one or more single products. When placing an order, for the quantity please enter single or multiples of a shipping unit.

ADDITIONAL CATALOG INFORMATION

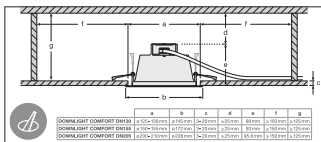
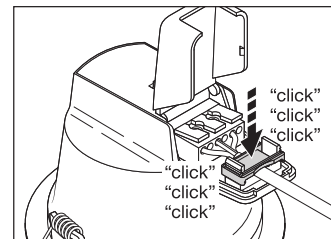
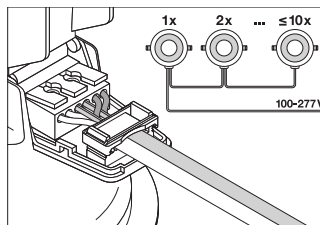
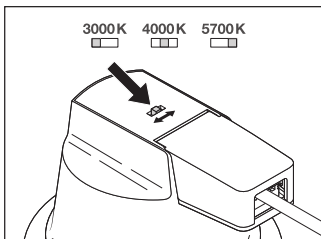

References / Links

– For Guarantee see www.ledvance.com/guarantee

DISCLAIMER

Subject to change without notice. Errors and omission excepted. Always make sure to use the most recent release.