

PRODUCTINFORMATIEBLAD

SF CIRC 350 V 18W 3CCT IP44

SURFACE CIRCULAR 350 3CCT | IP44 wand- en plafondarmatuur met instelbare CCT

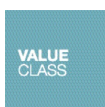

Toepassingsgebieden

- Gangen
- Trappenhuizen
- Badkamers
- Foyers

Productvoordelen

- Binnenverlichtingsarmatuur met hoge lichtopbrengst
- Zeer veelzijdig dankzij instelbare CCT in 3.000K, 4.000K en 5.000K
- Verlaagde totale hoogte van slechts 75 mm in vergelijking met de standaardversie
- Energiebesparing tot 55 % vergeleken met armaturen op basis van CFL technologie
- Eenvoudige en snelle installatie
- Zeer homogeen licht
- 5 jaar garantie

Productkenmerken

- Soort bescherming: IP44 (plafondmontage), IP20 (wandmontage)
- Verlengde levensduur (L70/B10): tot 50.000 uur (bij 25°C)
- Schokbestendigheid: IK03
- Metalen behuizing, PMMA afdekking
- Omgevingstemperatuur bij gebruik: -20...+40 °C
- Alleen voor gebruik binnenshuis, niet geschikt voor gebruik buitenshuis



TECHNISCHE GEGEVENS

ELEKTRISCHE GEGEVENS

Nominale vermogen	18,00 W
Nominale spanning	220...240 V
Netfrequentie	50...60 Hz
Nominale stroom	85,000 mA
Inschakelstroom	7,2 A
Inschakelstroomtijd T_{h50}	5.6 μ s
Max. armaturen op stroomonderbreke B16 A	104
Max. aantal armaturen per leidingbeveiligingsschakelaar C10	83
Max. aantal armaturen per leidingbeveiligingsschakelaar C16	133
Arbeidsfactor λ	> 0,70
Totale harmonische vervorming	< 60 %
Veiligheidsklasse	I
Bedrijfsmodus	Integrated LED driver

Fotometrische gegevens

Lichtstroom	1440 lm
Lichtstroom efficiëntie	80 lm/W
Kleurtemperatuur	3000 K / 4000 K / 5000 K
Referentieregelaar instelling van ingebouwde lichtbron (Kelvin)	4000 K
Lichtkleur	Warm White / Koel wit / daglicht
Kleurweergave-index Ra	> 80
Standaardafwijking van kleurproeven	< 6 sdc _m
Flikkervrij	Ja
Flikkerwaarde Pst LM	< 1
Stroboscoopeffect waarde SVM	< 0.4
Fotobiologische veiligheidsgroep EN62778	RG0
Stralingshoek	120 °

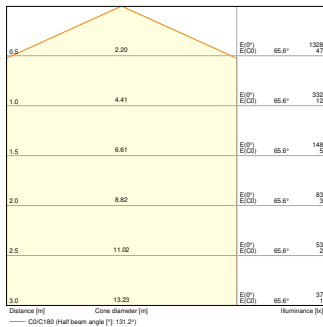

SF CIRC 350 V 18W 3CCT 3000K
IP44

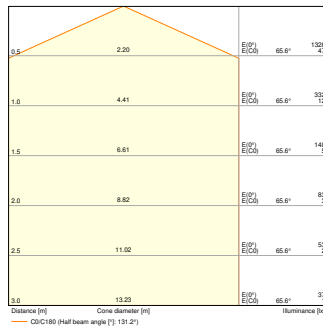

SF CIRC 350 V 18W 3CCT 4000K
IP44

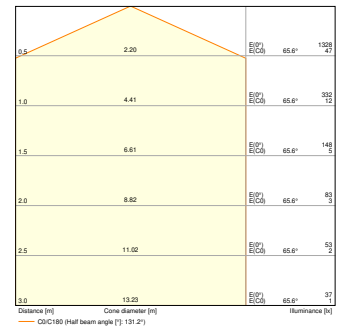

SF CIRC 350 V 18W 3CCT 5000K
IP44

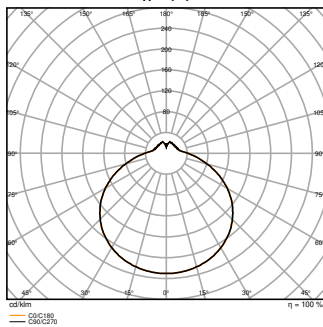

SF CIRC 350 V 18W 3CCT 3000K
IP44

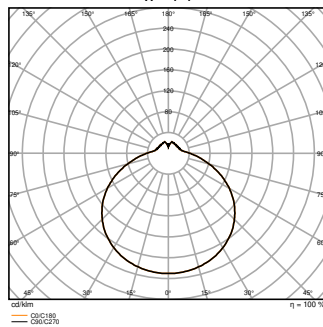

SF CIRC 350 V 18W 3CCT 4000K
IP44

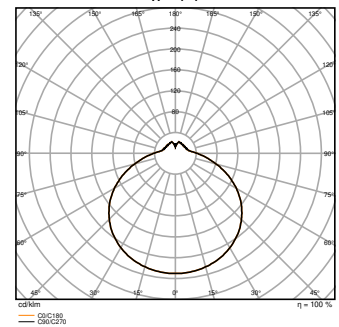

SF CIRC 350 V 18W 3CCT 5000K
IP44

AFMETINGEN & GEWICHT

Diameter	350 mm
Hoogte	75,00 mm
Product gewicht	560,00 g

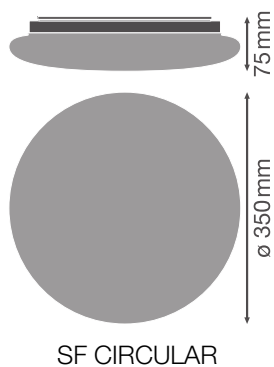

MATERIALEN & KLEUREN

Kleur van het product	Wit
Kleur behuizing	Wit
Body materiaal	Steel
Materiaal afdekking	Polymethylmethacrylate (PMMA)
Materiaal van lichtuitstralend oppervlak	PMMA
Glow Wire Test volgens IEC 60695-2-12	650 °C
Kwikgehalte	0.0 mg

TOEPASSING & MONTAGE

Omgevingstemperatuur bereik	-20...+40 °C
Opslagtemperatuur	-20...+80 °C
Type aansluiting	Terminal, 3-pins
Type bescherming	IP44
Beschermklasse IK (Schok bestendi [PIM]	IK03
Dimbaar	Nee
Montagetype	Surface
Montagelocatie	Plafond / Muur
Toepassingsomgeving	Indoor
Vervangbare LED module	Niet vervangbaar
Met lichtbron	Ja

Levensduur

Levensduur L70/B50 @ 25 °C	50000 h ¹⁾
Levensduur L80/B10 @ 25 °C	33000 h ¹⁾
Levensduur L90/B10 @ 25 °C	15000 h
Aantal schakelcycli	100000

¹⁾ t[h]: L70 / B50 @ 25 °C (Ta), t[h]: L80 / B10 @ 25 °C (Ta), t[h]: L90 / B10 @ 25 °C (Ta)

VOORSCHAKELAPPARATUUR

Uitgangsstroom:	220 mA
E-VSA - Uitgangsrimpelstroom	< 5 %

CERTIFICATEN & NORMEN

Normen	CE / CB / TUV / UKCA / EAC / EPD
Gelimiteerde oppervlaktetemperatuur	Nee
Balschot veilig	Nee

EPD

LEDV-00010-V01.01-EN

AANVULLENDE PRODUCTGEGEVENS











Toegevoegde functie













MULTI SELECT

Technische uitrusting

– Vervangende kap optioneel verkrijgbaar

DOWNLOADS

	Documenten en certificaten	Naam document
	User Instruction	UI SF CIRC 350 V and SF CIRC 350 SEN V
	Addon Technical Information	LSI SF CIRCULAR 350
	Legal information	Legal insert
	Declarations of conformity	SF SQUARE 330 V 24W 830 IP44
	Declarations Of Conformity UKCA	SF SQUARE and SF CIRC
	Fotometrische- en lichtontwerpbestanden	Naam document
	IES file (IES)	SF CIRC 350 V 18W 3CCT 3000K IP44
	IES file (IES)	SF CIRC 350 V 18W 3CCT 4000K IP44
	IES file (IES)	SF CIRC 350 V 18W 3CCT 5000K IP44
	LDT file (Eulumdat)	SF CIRC 350 V 18W 3CCT 3000K IP44
	LDT file (Eulumdat)	SF CIRC 350 V 18W 3CCT 4000K IP44
	LDT file (Eulumdat)	SF CIRC 350 V 18W 3CCT 5000K IP44
	ULD file (DIALux)	SF CIRC 350 SEN 18W 3CCT IP44

Fotometrische- en lichtontwerpbestanden		Naam document
	ROLF file (RELUX)	SF CIRC 350 V 3CCT 18W 3CCT IP44
	UGR file (UGR table)	SF CIRC 350 V 18W 3CCT 3000K IP44
	UGR file (UGR table)	SF CIRC 350 V 18W 3CCT 4000K IP44
	UGR file (UGR table)	SF CIRC 350 V 18W 3CCT 5000K IP44
	LDC typ cone	SF CIRC 350 V 18W 3CCT 3000K IP44
	LDC typ cone	SF CIRC 350 V 18W 3CCT 4000K IP44
	LDC typ cone	SF CIRC 350 V 18W 3CCT 5000K IP44
	LDC typ polar	SF CIRC 350 V 18W 3CCT 3000K IP44
	LDC typ polar	SF CIRC 350 V 18W 3CCT 4000K IP44
	LDC typ polar	SF CIRC 350 V 18W 3CCT 5000K IP44
CAD/BIM-bestanden		Naam document
	BIM_Revit_3D	SURFACE CIRCULAR
	CAD_STEP_3D	SF CIRC 350

LOGISTIEKE GEGEVENS

Productcode	Verpakkingseenheid (stuks per verpakking)	Afmetingen (lengte x breedte x hoogte)	Brutogewicht	Volume
4099854042072	Vouwdoos 1	87 mm x 382 mm x 384 mm	829.00 g	12.76 dm ³
4099854042089	Verzenddoos 5	457 mm x 392 mm x 419 mm	5374.00 g	75.06 dm ³

De genoemde productcodes beschrijven de kleinste hoeveelheid die besteld kan worden. Eén verzendeenheid kan bestaan uit één of meer afzonderlijke producten. Bij het plaatsen van een order enkele of veelvouden van de verpakkingseenheid invoeren.

AANVULLENDE CATALOGUSINFORMATIE

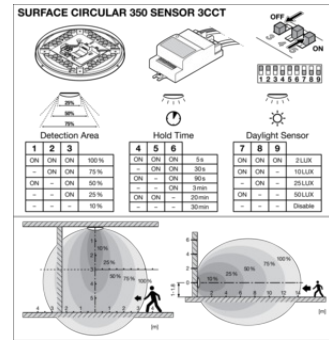
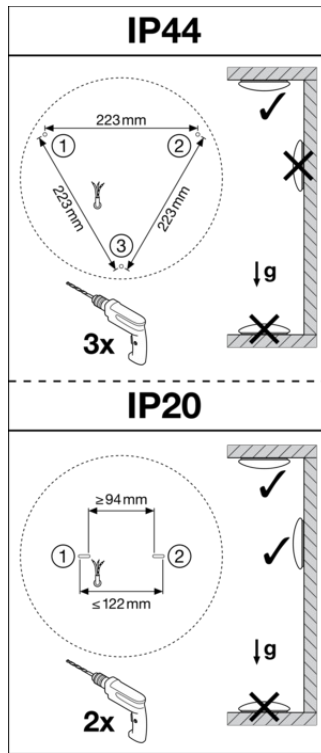
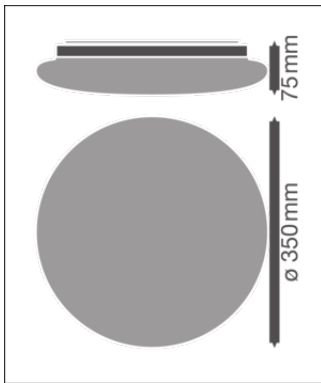

Referenties / Links

- Voor garantie zie www.benelux.ledvance.com/garantie

DISCLAIMER

Onder voorbehoud van verandering zonder kennisgeving. Fouten en drukfouten voorbehouden. Zorg ervoor dat u de meest recente versie gebruikt.