

PRODUCTINFORMATIEBLAD

SF SQUARE 330 SEN V 24W 3CCT IP44

SURFACE SQUARE 330 3CCT SENSOR | IP44 wand- en plafondarmatuur met en zonder HF sensor en instelbare CCT



Toepassingsgebieden

- Gangen
- Trappenhuizen
- Badkamers
- Foyers

Productvoordelen

- Eenvoudige aanpassing van sensorbereik, daglichtdetectie en insteltijd
- Binnenverlichtingsarmatuur met hoge lichtopbrengst
- Zeer veelzijdig dankzij instelbare CCT in 3.000K, 4.000K en 5.000K
- Energiebesparing tot 55 % vergeleken met armaturen op basis van CFL technologie
- Eenvoudige en snelle installatie
- Zeer homogeen licht
- 5 jaar garantie

Productkenmerken

- Hoogfrequente sensor voor daglicht- en bewegingsdetectie
- Soort bescherming: IP44 (plafondmontage), IP20 (wandmontage)
- Schokbestendigheid: IK03
- Metalen behuizing, PMMA afdekking
- Omgevingstemperatuur bij gebruik: -20...+40 °C



– Alleen voor gebruik binnenshuis, niet geschikt voor gebruik buitenshuis

TECHNISCHE GEGEVENS

ELEKTRISCHE GEGEVENS

Nominale vermogen	24,00 W
Nominale spanning	220...240 V
Netfrequentie	50...60 Hz
Nominale stroom	115,000 mA
Inschakelstroom	7,2 A
Inschakelstroomtijd T_{h50}	5.9 μ s
Max. armaturen op stroomonderbreke B16 A	104
Max. aantal armaturen per leidingbeveiligingsschakelaar C10	66
Max. aantal armaturen per leidingbeveiligingsschakelaar C16	106
Arbeidsfactor λ	> 0,70
Totale harmonische vervorming	< 60 %
Veiligheidsklasse	I
Bedrijfsmodus	Integrated LED driver

Fotometrische gegevens

Lichtstroom	2000 lm
Lichtstroom efficiëntie	83 lm/W
Kleurtemperatuur	3000 K / 4000 K / 5000 K
Referentieregelaar instelling van ingebouwde lichtbron (Kelvin)	4000 K
Lichtkleur	Warm White / Koel wit / daglicht
Kleurweergave-index Ra	> 80
Standaardafwijking van kleurproeven	< 6 sdc _m
Flikkervrij	Ja
Flikkerwaarde Pst LM	< 1
Stroboscoopeffect waarde SVM	< 0.4
Fotobiologische veiligheidsgroep EN62778	RG0
Stralingshoek	120 °

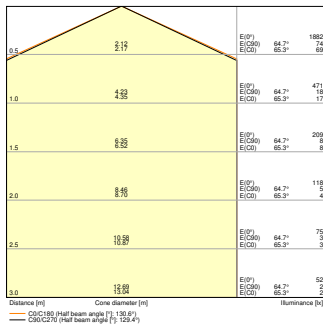

SF SQUARE 330 SEN V 24W 3CCT
3000K IP44

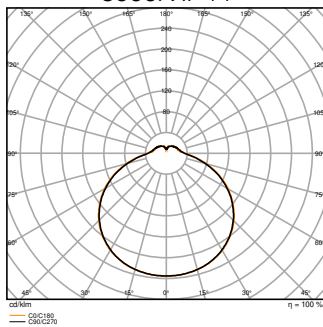

SF SQUARE 330 SEN V 24W 3CCT
3000K IP44

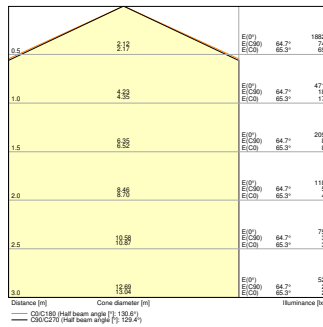

SF SQUARE 330 SEN V 24W 3CCT
4000K IP44

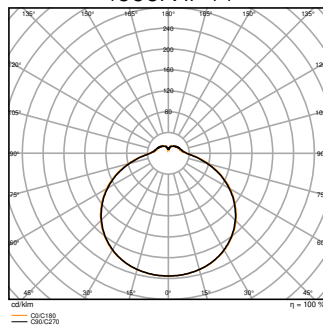

SF SQUARE 330 SEN V 24W 3CCT
4000K IP44

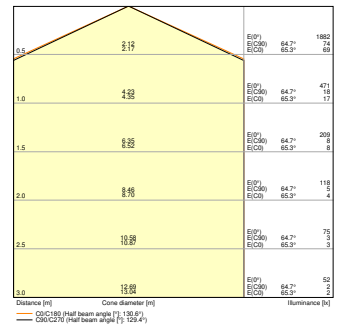

SF SQUARE 330 SEN V 24W 3CCT
5000K IP44

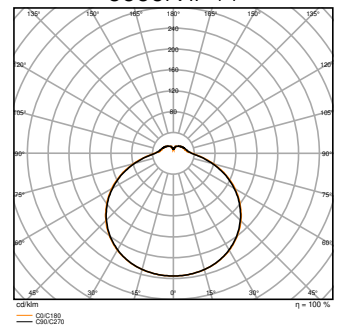

SF SQUARE 330 SEN V 24W 3CCT
5000K IP44

AFMETINGEN & GEWICHT

Lengte	330,00 mm
Breedte	330,00 mm
Hoogte	75,00 mm
Product gewicht	755,00 g

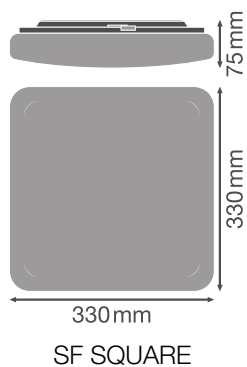

MATERIALEN & KLEUREN

Kleur van het product	Wit
Kleur behuizing	Wit
Body materiaal	Steel
Materiaal afdekking	Polymethylmethacrylate (PMMA)
Materiaal van lichtuitstralend oppervlak	PMMA
Glow Wire Test volgens IEC 60695-2-12	650 °C
Kwikgehalte	0.0 mg

TOEPASSING & MONTAGE

Omgevingstemperatuur bereik	-20...+40 °C
Opslagtemperatuur	-20...+80 °C
Type aansluiting	Terminal, 3-pins
Type bescherming	IP44
Beschermklasse IK (Schok bestendi [PIM]	IK03
Dimbaar	Nee
Montagetype	Surface
Montagelocatie	Plafond / Muur
Toepassingsomgeving	Indoor
Vervangbare LED module	Niet vervangbaar
Met lichtbron	Ja

Levensduur

Levensduur L70/B50 @ 25 °C	50000 h ¹⁾
Levensduur L80/B10 @ 25 °C	33000 h ¹⁾
Levensduur L90/B10 @ 25 °C	15000 h
Aantal schakelcycli	100000

¹⁾ t[h]: L70 / B50 @ 25 °C (Ta), t[h]: L80 / B10 @ 25 °C (Ta), t[h]: L90 / B10 @ 25 °C (Ta)

VOORSCHAKELAPPARATUUR

Uitgangsstroom:	300 mA
E-VSA - Uitgangsrimpelstroom	< 5 %

SENSOR

Type sensor	Beweging / Licht
Sensortechnologie	Microgolf

Detectiehoek sensor	120 °
Sensorgestuurde schakeltijd	5 s...30 min
Detectiebereik van bewegingssensor	4...7 m
Detectiedrempel van daglichtsensor	2...50 lx
Sensor IK-classificatie	IK03

CERTIFICATEN & NORMEN

Normen	CE / CB / TUV / UKCA / EAC
Gelimiteerde oppervlaktetemperatuur	Nee
Balschot veilig	Nee







AANVULLENDE PRODUCTGEGEVENS

















Toegevoegde functie	MULTI SELECT
---------------------	--------------

Technische uitrusting

– Vervangende kap optioneel verkrijgbaar

DOWNLOADS

Documenten en certificaten	Naam document
 User Instruction	UI SF SQUARE 330 V and SF SQUARE 330 SEN V
 Addon Technical Information	LSI SF SQUARE 330 V 24W
 Legal information	Legal Insert SF CIRC SEN V IP44
 Declarations of conformity	SF SQUARE and SF CIRC
 Declarations Of Conformity UKCA	SF SQUARE and SF CIRC
Fotometrische- en lichtontwerpbestanden	Naam document
 IES file (IES)	SF SQUARE 330 SEN V 24W 3CCT 3000K IP44
 IES file (IES)	SF SQUARE 330 SEN V 24W 3CCT 4000K IP44

Fotometrische- en lichtontwerpbestanden		Naam document
	IES file (IES)	SF SQUARE 330 SEN V 24W 3CCT 5000K IP44
	LDT file (Eulumdat)	SF SQUARE 330 SEN V 24W 3CCT 3000K IP44
	LDT file (Eulumdat)	SF SQUARE 330 SEN V 24W 3CCT 4000K IP44
	LDT file (Eulumdat)	SF SQUARE 330 SEN V 24W 3CCT 5000K IP44
	ULD file (DIALux)	SF SQUARE 330V SEN 24W 3CCT IP44
	ROLF file (RELUX)	SF SQUARE 330 3CCT SEN 24W 3CCT IP44
	UGR file (UGR table)	SF SQUARE 330 SEN V 24W 3CCT 3000K IP44
	UGR file (UGR table)	SF SQUARE 330 SEN V 24W 3CCT 4000K IP44
	UGR file (UGR table)	SF SQUARE 330 SEN V 24W 3CCT 5000K IP44
	LDC typ cone	SF SQUARE 330 SEN V 24W 3CCT 3000K IP44
	LDC typ cone	SF SQUARE 330 SEN V 24W 3CCT 4000K IP44
	LDC typ cone	SF SQUARE 330 SEN V 24W 3CCT 5000K IP44
	LDC typ polar	SF SQUARE 330 SEN V 24W 3CCT 3000K IP44
	LDC typ polar	SF SQUARE 330 SEN V 24W 3CCT 4000K IP44
	LDC typ polar	SF SQUARE 330 SEN V 24W 3CCT 5000K IP44
CAD/BIM-bestanden		Naam document
	BIM_Revit_3D	SF SQUARE
	CAD_STEP_3D	SF SQUARE 330

LOGISTIEKE GEGEVENS

Productcode	Verpakkingseenheid (stuks per verpakking)	Afmetingen (lengte x breedte x hoogte)	Brutogewicht	Volume
4099854042058	Vouwdoos 1	87 mm x 367 mm x 369 mm	1016.00 g	11.78 dm ³
4099854042065	Verzenddoos 5	457 mm x 387 mm x 404 mm	6271.00 g	71.45 dm ³

Productcode	Verpakkingseenheid (stuks per verpakking)	Afmetingen (lengte x breedte x hoogte)	Brutogewicht	Volume
-------------	---	--	--------------	--------

De genoemde productcodes beschrijven de kleinste hoeveelheid die besteld kan worden. Eén verzendeenheid kan bestaan uit één of meer afzonderlijke producten. Bij het plaatsen van een order enkele of veelvoud van de verpakkingseenheid invoeren.

AANVULLENDE CATALOGUSINFORMATIE

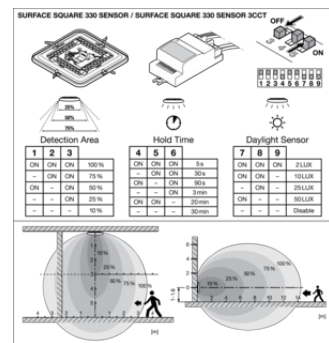
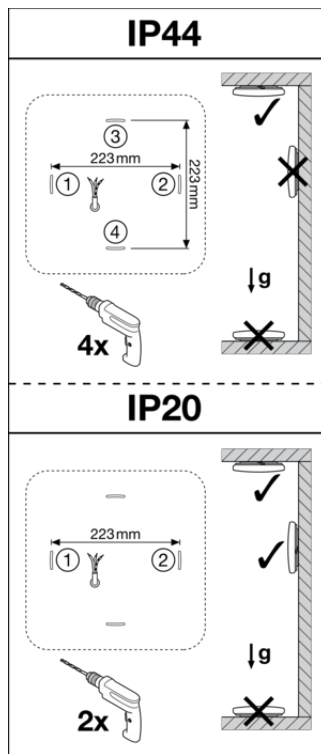
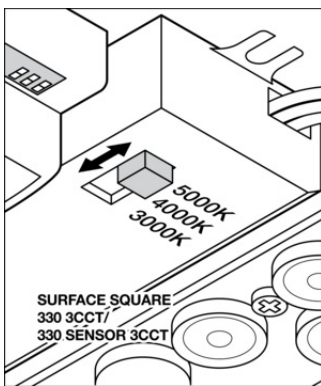
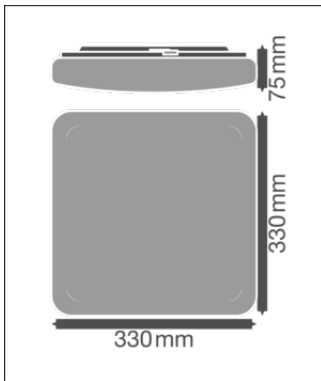

Referenties / Links

- Voor garantie zie www.benelux.ledvance.com/garantie

DISCLAIMER

Onder voorbehoud van verandering zonder kennisgeving. Fouten en drukfouten voorbehouden. Zorg ervoor dat u de meest recente versie gebruikt.