

PRODUCT DATASHEET

SF SQUARE 330 V 24W 3CCT IP44

SURFACE SQUARE 330 3CCT | Wall and ceiling luminaire with IP44 and selectable CCT



Areas of application

- Corridors
- Stairways
- Bathrooms
- Foyers

Product benefits

- Indoor luminaire with high luminous efficacy
- Highly versatile due to selectable CCT in 3000K, 4000K and 5000K
- Energy savings of up to 55 % compared to luminaires that use CFL
- Easy and quick installation
- Very homogenous light
- 5 years guarantee

Product features

- Type of protection: IP44 (ceiling mounting), IP20 (wall mounting)
- Impact resistance: IK03
- Metal housing, PMMA cover
- Ambient temperature in operation: -20...+40 °C
- Indoor use only, not suitable for outdoor use



TECHNICAL DATA

Electrical data

Nominal wattage	24.00 W
Nominal voltage	220...240 V
Mains frequency	50...60 Hz
Nominal current	115.000 mA
Inrush current	7.2 A
Inrush current time T_{h50}	5.9 μ s
Max. number of luminaires per miniature circuit breaker B16	104
Max. number of luminaires per miniature circuit breaker C10	66
Max. number of luminaires per miniature circuit breaker C16	106
Power factor λ	> 0.70
Total harmonic distortion	< 60 %
Protection class	I
Operating mode	Integrated LED driver

Photometrical data

Luminous flux	2000 lm
Luminous efficacy	83 lm/W
Color temperature	3000 K / 4000 K / 5000 K
Reference control setting of contained light source (Kelvin)	4000 K
Light color (designation)	Warm White / Cool White / Daylight
Color rendering index Ra	> 80
Standard deviation of color matching	< 6 sdc _m
Low flicker	Yes
Flickering metric (Pst LM)	< 1
Stroboscope effect metric (SVM)	< 0.4
Photobiological safety group acc. to EN62778	RG0
Beam angle	120 °

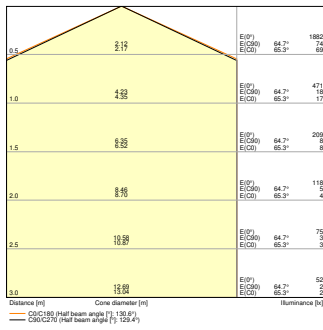

SF SQUARE 330 V 24W 3CCT
3000K IP44

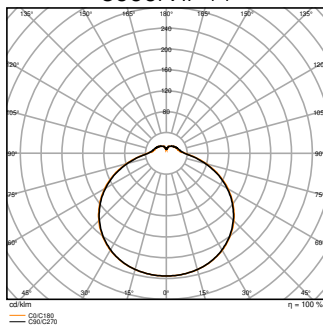

SF SQUARE 330 V 24W 3CCT
3000K IP44

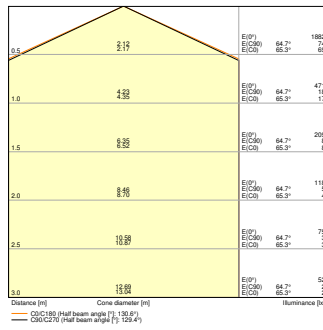

SF SQUARE 330 V 24W 3CCT
4000K IP44

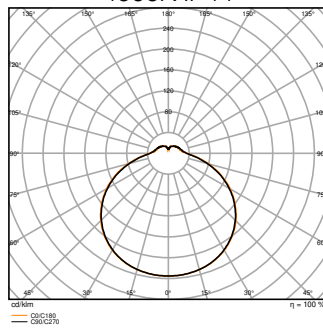

SF SQUARE 330 V 24W 3CCT
4000K IP44

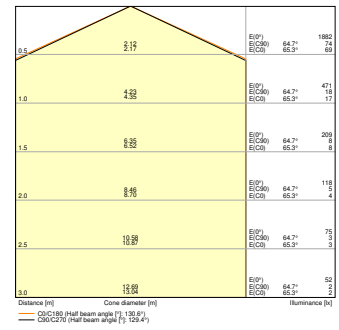

SF SQUARE 330 V 24W 3CCT
5000K IP44

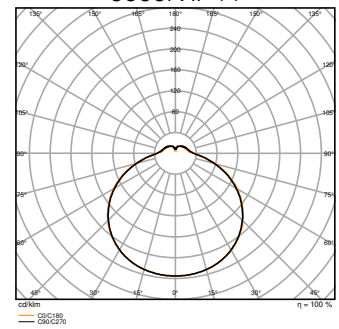

SF SQUARE 330 V 24W 3CCT
5000K IP44

Dimensions & Weight

Length	330.00 mm
Width	330.00 mm
Height	75.00 mm
Product weight	720.00 g

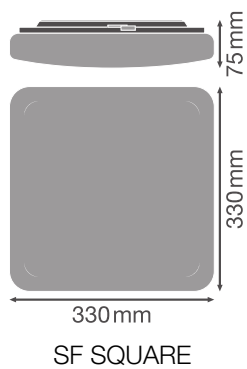

Materials & Colors

Product color	White
Housing color	White
Body material	Steel
Cover material	Polymethylmethacrylate (PMMA)
Light emitting surface material	PMMA
Glow Wire Test according to IEC 60695-2-12	650 °C
Mercury content	0.0 mg

Application & Mounting

Ambient temperature range	-20...+40 °C
Temperature range at storage	-20...+80 °C
Type of connection	Terminal, 3-pin
Type of protection	IP44
Protection class IK (shock resistance)	IK03
Dimmable	No
Mounting type	Surface
Mounting location	Ceiling / Wall
Application environment	Indoor
LED module replaceable	Not replaceable
With light source	Yes

Lifespan

Lifespan L70/B50 at 25 °C	50000 h ¹⁾
Lifespan L80/B10 at 25 °C	33000 h ¹⁾
Lifespan L90/B10 at 25 °C	15000 h
Number of switching cycles	100000

¹⁾ t[h]: L70 / B50 @ 25 °C (Ta), t[h]: L80 / B10 @ 25 °C (Ta), t[h]: L90 / B10 @ 25 °C (Ta)

Control gear

Output current	300 mA
ECG - Output ripple current	< 5 %

Certificates & Standards

Standards	CE / CB / TÜV / UKCA / EAC
Luminaire with limited surface temperature, "D sign"	No

Ball shot safe	No
----------------	----





Additional product data







Added function	MULTI SELECT
----------------	--------------











EQUIPMENT / ACCESSORIES



– Replacement cover optionally available

DOWNLOAD DATA

	Documents and certificates	Document name
	User Instruction	UI SF SQUARE 330 V and SF SQUARE 330 SEN V
	Addon Technical Information	LSI SF SQUARE 330 V 24W
	Legal information	Legal insert
	Declarations of conformity	SF SQUARE 330 V 24W 830 IP44
	Declarations Of Conformity UKCA	SF SQUARE and SF CIRC

	Photometric and lighting design files	Document name
	IES file (IES)	SF SQUARE 330 V 24W 3CCT 5000K IP44
	IES file (IES)	SF SQUARE 330 V 24W 3CCT 4000K IP44
	IES file (IES)	SF SQUARE 330 V 24W 3CCT 3000K IP44
	LDT file (Eulumdat)	SF SQUARE 330 V 24W 3CCT 3000K IP44
	LDT file (Eulumdat)	SF SQUARE 330 V 24W 3CCT 4000K IP44
	LDT file (Eulumdat)	SF SQUARE 330 V 24W 3CCT 5000K IP44
	ULD file (DIALux)	SF SQUARE 330V SEN 24W 3CCT IP44

Photometric and lighting design files		Document name
	ROLF file (RELUX)	SF SQUARE 330 V 3CCT 24W IP44
	UGR file (UGR table)	SF SQUARE 330 V 24W 3CCT 3000K IP44
	UGR file (UGR table)	SF SQUARE 330 V 24W 3CCT 4000K IP44
	UGR file (UGR table)	SF SQUARE 330 V 24W 3CCT 5000K IP44
	LDC typ cone	SF SQUARE 330 V 24W 3CCT 3000K IP44
	LDC typ cone	SF SQUARE 330 V 24W 3CCT 4000K IP44
	LDC typ cone	SF SQUARE 330 V 24W 3CCT 5000K IP44
	LDC typ polar	SF SQUARE 330 V 24W 3CCT 3000K IP44
	LDC typ polar	SF SQUARE 330 V 24W 3CCT 4000K IP44
	LDC typ polar	SF SQUARE 330 V 24W 3CCT 5000K IP44

CAD/BIM files		Document name
	BIM_Revit_3D	SF SQUARE
	CAD_STEP_3D	SF SQUARE 330

Tender texts		Document name
	Tender documents	SURFACE SQUARE 330 3CCT 24W 3CCT IP44-EN

LOGISTICAL DATA

Product code	Packaging unit (Pieces/Unit)	Dimensions (length x width x height)	Gross weight	Volume
4099854042034	Folding box 1	87 mm x 367 mm x 369 mm	981.00 g	11.78 dm ³
4099854042041	Shipping box 5	457 mm x 387 mm x 404 mm	6096.00 g	71.45 dm ³

The mentioned product code describes the smallest quantity unit which can be ordered. One shipping unit can contain one or more single products. When placing an order, for the quantity please enter single or multiples of a shipping unit.

ADDITIONAL CATALOG INFORMATION

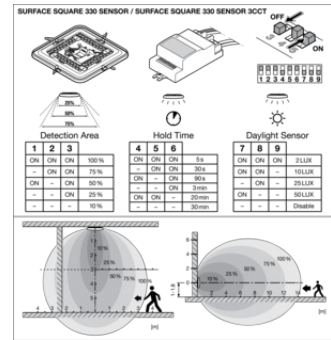
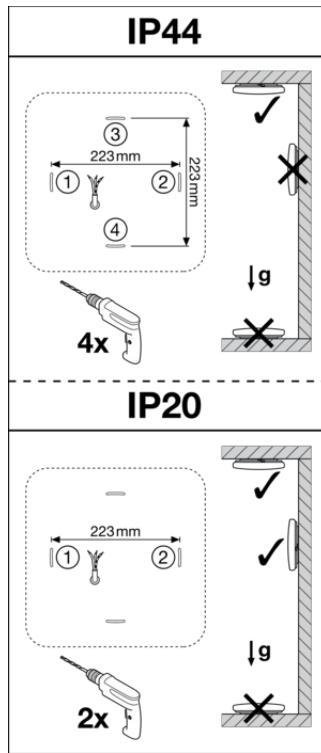
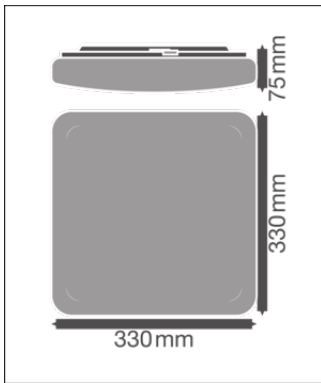

References / Links

- For Guarantee see www.ledvance.com/guarantee

DISCLAIMER

Subject to change without notice. Errors and omission excepted. Always make sure to use the most recent release.