

PRODUCT DATASHEET

FL COMP SEN V 10W 840 SYM 100 BK

FLOODLIGHT COMPACT SENSOR 10W | Sensor floodlight with up to 1000 lm light output



Areas of application

- Replacement for floodlights with halogen lamps
- Outdoor use (IP65)
- Public areas
- Building facades
- Gardens, balconies and other outdoor areas
- Construction areas

Product benefits

- Robust, yet light and compact design
- Demand optimized illumination due to flexible and programmable sensor
- Easy adjustment of sensor range, daylight detection and hold time
- Always-on override, activated via special mains switching pattern
- Safe and very uniform illumination, due to frosted and tempered glass diffuser
- No upper light output ratio (ULOR 0%) when mounted at 0° tilt
- Energy savings of up to 90 % compared to halogen lamp floodlights
- 3 years guarantee

Product features

- Flexible motion and daylight sensor
- Sensor with 350° pan and 180° tilt
- Reflector-based, symmetric light distribution with 100° x 100° beam angle
- Mounting bracket with 30° angle and wide rotation area
- Pre-installed, flexible 1 m cable (H05RN-F), wrapped 3 x 1.0 mm² single wires



TECHNICAL DATA

Electrical data

Nominal wattage	10.00 W
Nominal voltage	220...240 V
Mains frequency	50...60 Hz
Nominal current	55 mA
Inrush current	6.3 A
Inrush current time T_{h50}	2.3 μ s
Max. number of luminaires per miniature circuit breaker B16	159
Max. number of luminaires per miniature circuit breaker C10	116
Max. number of luminaires per miniature circuit breaker C16	185
Power factor λ	> 0.80
Total harmonic distortion	< 20 %
Protection class	I
Operating mode	Integrated LED driver

Photometrical data

Luminous flux	1000 lm
Luminous efficacy	100 lm/W
Color temperature	4000 K
Light color (designation)	Cool White
Color rendering index Ra	\geq 80
Standard deviation of color matching	< 5 sdc _m
Luminous intensity	-
Low flicker	Yes
Flickering metric (Pst LM)	-
Stroboscope effect metric (SVM)	-
Photobiological safety group acc. to EN62778	RG1
Photobiological safety group acc. to EN62471	RG1
Beam angle	100 ° x 100 °

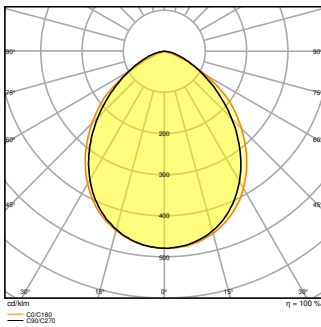

FL COMP V 10W 840 SYM 100 WT

Dimensions & Weight

Length	153.00 mm
Width	109.00 mm
Height	53.00 mm
Product weight	330.00 g
Cable length	1000 mm

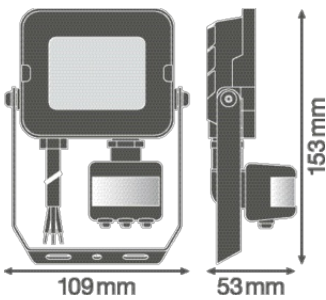

FL COMP SEN V 10W SYM 100 BK

Materials & Colors

Product color	Black
Housing color	Black
Body material	Aluminum
Cover material	Tempered glass
Light emitting surface material	Glass
Glow Wire Test according to IEC 60695-2-12	650 °C

Mercury content	0.0 mg
-----------------	--------

Application & Mounting

Ambient temperature range	-30...+45 °C
Temperature range at storage	-40...+70 °C
Type of connection	Cable, 3-pole
Type of protection	IP65
Protection class IK (shock resistance)	IK06
Dimmable	No
Mounting type	Surface
Mounting location	Wall / Pole / Floor
Application environment	Outdoor
Adjustable	Yes
LED module replaceable	Not replaceable
With light source	Yes

Lifespan

Lifespan L70/B50 at 25 °C	50000 h ¹⁾
Lifespan L80/B10 at 25 °C	35000 h ¹⁾
Lifespan L90/B10 at 25 °C	25000 h
Number of switching cycles	100000

¹⁾ t[h]: L70 / B50 @ 25 °C (Ta), t[h]: L80 / B10 @ 25 °C (Ta), t[h]: L90 / B10 @ 25 °C (Ta)

Sensor





Type of sensor	Motion / Light
Sensor technology	Passive infrared/Photocell
Sensor detection angle	40 °...160 °
Sensor controlled switching time	10 s...12 min
Detection range of motion sensor	2...12 m
Detection threshold of daylight sensor	10...2000 lx
Sensor IP rating	IP65
Sensor IK rating	IK05





Certificates & Standards

Standards	CE / CB / EAC
Luminaire with limited surface temperature, "D sign"	No

Ball shot safe	No
----------------	----

DOWNLOAD DATA

Documents and certificates		Document name
	User Instruction	FL COMP SEN V SYM
	Addon Technical Information	LSI FL COMP SEN V
	Legal information	Legal Insert FL COMP/SENSOR
	Declarations of conformity	FL COMP
	Declarations Of Conformity UKCA	FL COMP SEN V SYM 100 BK

Photometric and lighting design files		Document name
	IES file (IES)	FL COMP SEN V 10W 840 SYM 100 BK
	LDT file (Eulumdat)	FL COMP SEN V 10W 840 SYM 100 BK
	ULD file (DIALux)	FL COMP SEN V 10W 840
	ROLF file (RELUX)	FL COMP SEN V 10W 840 SYM 100 BK
	LDC typ polar	FL COMP V 10W 840 SYM 100 WT

CAD/BIM files		Document name
	CAD_STEP_3D	FL COMP 10W SEN

Tender texts		Document name
	Tender documents	FLOODLIGHT COMPACT SENSOR 10W 840 SYM 100 BK-EN

LOGISTICAL DATA

Product code	Packaging unit (Pieces/Unit)	Dimensions (length x width x height)	Gross weight	Volume
--------------	------------------------------	--------------------------------------	--------------	--------

Product code	Packaging unit (Pieces/Unit)	Dimensions (length x width x height)	Gross weight	Volume
4058075575240	Folding box 1	114 mm x 78 mm x 161 mm	373.00 g	1.43 dm ³
4058075575257	Shipping box 8	330 mm x 244 mm x 190 mm	3282.00 g	15.30 dm ³

The mentioned product code describes the smallest quantity unit which can be ordered. One shipping unit can contain one or more single products. When placing an order, for the quantity please enter single or multiples of a shipping unit.

ADDITIONAL CATALOG INFORMATION

References / Links

– For Guarantee see www.ledvance.com/guarantee

DISCLAIMER

Subject to change without notice. Errors and omission excepted. Always make sure to use the most recent release.