

PRODUCT DATASHEET

FL PFM 10 W 3000 K SYM 100 S WT

FLOODLIGHT SENSOR 10 W | Floodlight with flexible motion and daylight sensor, up to 1200 lm light output



Areas of application

- Replacement for floodlights with halogen lamps
- Outdoor use (IP65)
- Public areas
- Building facades
- Construction areas
- Gardens, balconies and other outdoor areas

Product benefits

- Bright, robust and durable
- Demand optimized illumination due to flexible and programmable sensor
- Easy adjustment of sensor range, daylight detection and hold time
- Always-on override, activated via special mains switching pattern
- Safe and very uniform illumination, due to frosted and tempered glass diffuser
- No upper light output ratio (ULOR 0%) when mounted at 0° tilt
- Energy savings of up to 90 % compared to halogen lamp floodlights
- 5 years guarantee

Product features

- Flexible motion and daylight sensor
- Sensor with 350° pan and 180° tilt
- Reflector-based, symmetric light distribution with 100° x 100° beam angle
- Integrated wide voltage driver, suitable for 100 - 277 V AC
- Surge protection: up to 4 kV (L/N-PE), 2 kV (L-N)



- Mounting bracket with 30° angle and wide rotation area
- Pre-installed, flexible 1 m cable (H05RN-F), wrapped 3 x 1.0 mm² single wires

TECHNICAL DATA

Electrical data

Nominal wattage	10.00 W
Nominal voltage	100...277 V
Mains frequency	50...60 Hz
Nominal current	48 mA
Inrush current	7.2 A
Inrush current time T_{h50}	21 μ s
Max. number of luminaires per miniature circuit breaker B16	185
Max. number of luminaires per miniature circuit breaker C10	135
Max. number of luminaires per miniature circuit breaker C16	216
Power factor λ	> 0.90
Total harmonic distortion	< 20 %
Protection class	I
Operating mode	Integrated LED driver

Photometrical data

Luminous flux	1100 lm
Luminous efficacy	110 lm/W
Color temperature	3000 K
Light color (designation)	Warm White
Color rendering index Ra	≥ 80
Standard deviation of color matching	≤ 5 sdc _m
Luminous intensity	-
Flickering metric (Pst LM)	-
Stroboscope effect metric (SVM)	-
Photobiological safety group acc. to EN62778	RG1
Photobiological safety group acc. to EN62471	RG1
Beam angle	100 ° x 100 °



FL PFM 10W3000K SYM 100 S WT

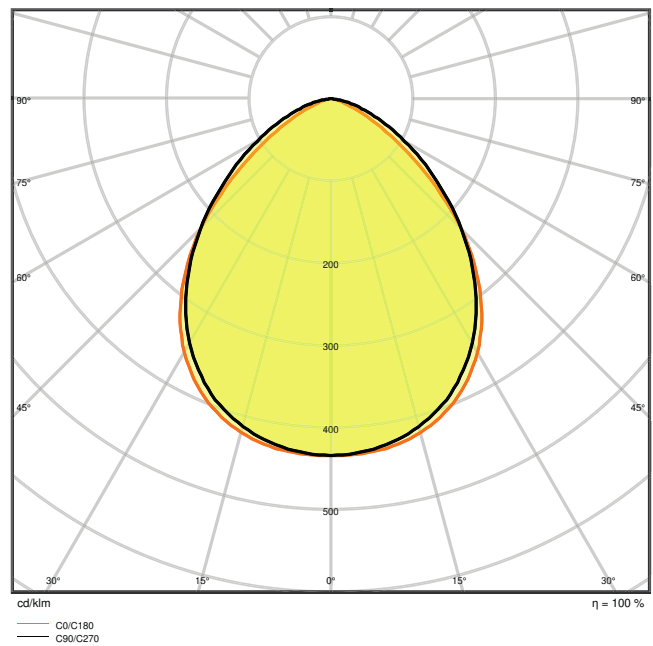

FL PFM 10W3000K SYM 100 S WT

Dimensions & Weight

Length	159.00 mm
Width	131.00 mm
Height	53.00 mm
Product weight	440.00 g
Cable length	1000 mm

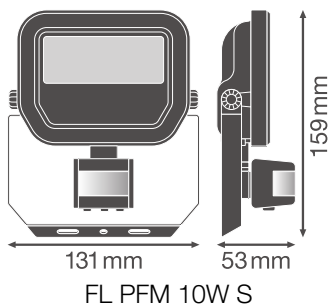

Materials & Colors

Product color	White
---------------	-------

Housing color	White
Body material	Aluminum
Light emitting surface material	Glass
Glow Wire Test according to IEC 60695-2-12	650 °C
Mercury content	0.0 mg

Application & Mounting

Ambient temperature range	-30...+50 °C
Temperature range at storage	-40...+70 °C
Type of connection	Cable, 3-pole
Type of protection	IP65
Protection class IK (shock resistance)	IK07
Dimmable	No
Mounting type	Surface
Mounting location	Wall / Ceiling
Application environment	Outdoor
Adjustable	Yes
LED module replaceable	Not replaceable
With light source	Yes

Lifespan

Lifespan L70/B50 at 25 °C	70000 h ¹⁾
Lifespan L80/B10 at 25 °C	55000 h ¹⁾
Lifespan L90/B10 at 25 °C	35000 h
Number of switching cycles	100000

¹⁾ t[h]: L70 / B50 @ 25 °C (Ta), t[h]: L80 / B10 @ 25 °C (Ta), t[h]: L90 / B10 @ 25 °C (Ta)

Control gear

Output current	220 mA
ECG - Output ripple current	< 50 %

Sensor





Type of sensor	Motion / Light
Sensor technology	Passive infrared/Photocell
Sensor detection angle	40 °...160 °
Sensor controlled switching time	10 s...12 min







Detection range of motion sensor	2...12 m
Detection threshold of daylight sensor	10...2000 lx
Sensor IP rating	IP65



Certificates & Standards

Standards	CE / CB / ENEC / EAC / RoHS / EPD
Luminaire with limited surface temperature, "D sign"	No
Ball shot safe	No
EPD	LEDV-00009-V01.01-EN

DOWNLOAD DATA

Documents and certificates		Document name
	User Instruction	FLOODLIGHT SENSOR
	Addon Technical Information	LSI FL PFM SYM
	Legal information	FL PFM SYM
	Declarations of conformity	FL PFM SENSOR
	Certificates	CEE Eligibility Attestation BAR-EQ-110 FR

Photometric and lighting design files		Document name
	IES file (IES)	FL PFM 10W3000K SYM 100 S WT
	LDT file (Eulumdat)	FL PFM 10W3000K SYM 100 S WT
	ULD file (DIALux)	FL PFM 10W-3000K SYM 100 S WT
	ROLF file (RELUX)	FL PFM 10W-3000K
	UGR file (UGR table)	FL PFM 10W3000K SYM 100 S WT
	LDC typ cone	FL PFM 10W3000K SYM 100 S WT
	LDC typ polar	FL PFM 10W3000K SYM 100 S WT

CAD/BIM files		Document name
	BIM_Revit_3D	Floodlight Sensor G3
	CAD_STEP_3D	FL G3 SEN 10W







Tender texts		Document name
	Tender documents	FLOODLIGHT SENSOR 10 W 3000 K SYM 100 S WT-EN

LOGISTICAL DATA

Product code	Packaging unit (Pieces/Unit)	Dimensions (length x width x height)	Gross weight	Volume
4058075460850	Folding box 1	65 mm x 137 mm x 167 mm	498.00 g	1.49 dm ³
4058075460867	Shipping box 12	403 mm x 283 mm x 184 mm	6509.00 g	20.99 dm ³

The mentioned product code describes the smallest quantity unit which can be ordered. One shipping unit can contain one or more single products. When placing an order, for the quantity please enter single or multiples of a shipping unit.

ADDITIONAL CATALOG INFORMATION

	SENS 	LUX 	TIME 
	~2 m	< 10 lx	~10 sec ± 3 sec
	~6 m	< 100 lx	~5 min ± 2 min
	~12 m	< 2000 lx	~12 min ± 3 min

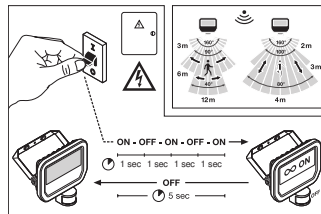

	A	B	C	IP	LED
10W	58	38	5.5	2x M5	0.012m ²
20W	79	58	6.5	2x M8	0.016m ²
50W	108	78	8.5	2x M8	0.032m ²

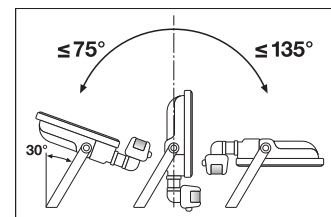
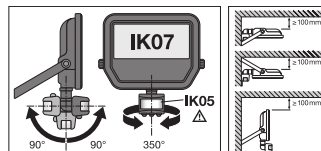
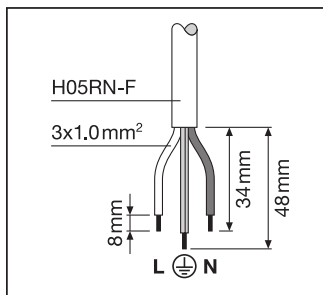

References / Links

– For Guarantee see www.ledvance.com/guarantee

DISCLAIMER

Subject to change without notice. Errors and omission excepted. Always make sure to use the most recent release.