

PRODUCT DATASHEET

SF CIRC 500 SEN V 42W 830 IP44 PS

SURFACE CIRCULAR 500 SENSOR PS | Wall and ceiling luminaire with IP44, high frequency sensor and power select (PS)



Areas of application

- Corridors
- Stairways
- Bathrooms
- Foyers

Product benefits

- Easy adjustment of sensor range, daylight detection and hold time
- Highly versatile due to selectable power steps (Power Select - PS) on the driver
- Indoor luminaire with high luminous efficacy
- Energy savings of up to 55 % compared to luminaires that use CFL
- Easy and quick installation
- Very homogenous light
- 5 years guarantee

Product features

- High frequency sensor for daylight and motion detection
- Type of protection: IP44 (ceiling mounting), IP20 (wall mounting)
- Extended lifetime (L70/B10): up to 50,000 h (at 25°C)
- Impact resistance: IK03
- Metal housing, PMMA cover



- Ambient temperature in operation: -20...+40 °C
- Indoor use only, not suitable for outdoor use

TECHNICAL DATA

Electrical data

Nominal wattage	42 W / 30 W / 19 W ¹⁾
Nominal voltage	220...240 V
Mains frequency	50...60 Hz
Nominal current	185.000 mA
Inrush current	23.6 A
Inrush current time T_{h50}	480 μ s
Max. number of luminaires per miniature circuit breaker B16	7
Max. number of luminaires per miniature circuit breaker C10	7
Max. number of luminaires per miniature circuit breaker C16	11
Power factor λ	> 0.90
Total harmonic distortion	< 30 %
Protection class	I
Operating mode	Integrated LED driver

¹⁾ For possible options refer to lumen/power table image

Photometrical data

Luminous flux	3500 lm / 2500 lm / 1500 lm ¹⁾
Luminous efficacy	83 lm/W / 78 lm/W ¹⁾
Color temperature	3000 K
Light color (designation)	Warm white
Color rendering index Ra	> 80
Standard deviation of color matching	< 5 sdc _m
Low flicker	Yes
Flickering metric (Pst LM)	<1
Stroboscope effect metric (SVM)	<0.4
Photobiological safety group acc. to EN62778	RG0
Beam angle	120 °

¹⁾ For possible options refer to lumen/power table image

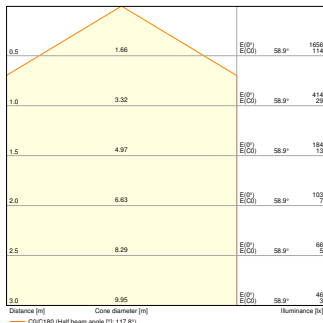

SF CIRC 500 SEN V 42W 830 IP44
PS 1500lm

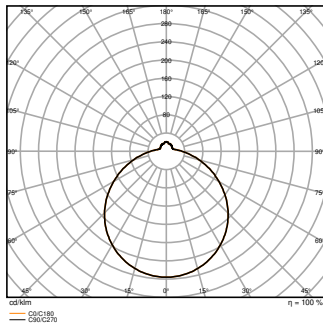

SF CIRC 500 SEN V 42W 830 IP44
PS 1500lm

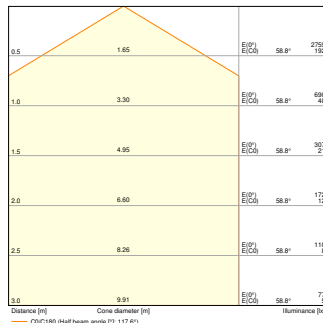

SF CIRC 500 SEN V 42W 830 IP44
PS 2500lm

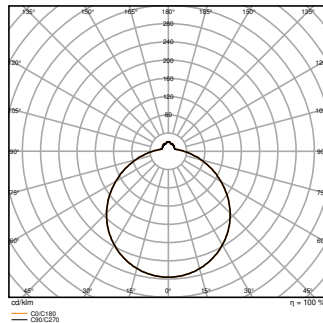

SF CIRC 500 SEN V 42W 830 IP44
PS 2500lm

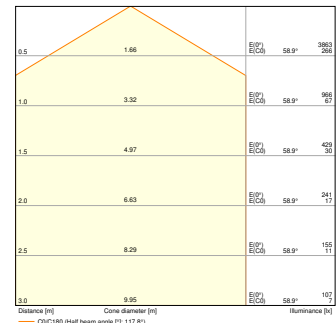

SF CIRC 500 SEN V 42W 830 IP44
PS 3500lm

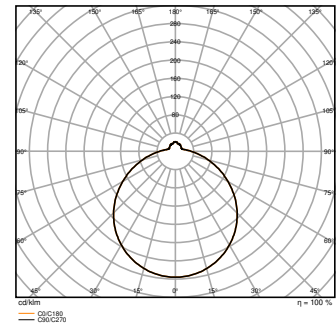

SF CIRC 500 SEN V 42W 830 IP44
PS 3500lm

Dimensions & Weight

Diameter	500.00 mm
Height	105.00 mm
Product weight	1200.00 g

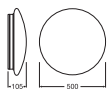

SF CIRC 500 V 42W IP44 PS and
SF CIRC 500 SEN V 42W IP44 PS

Materials & Colors

Product color	White
Housing color	White
Body material	Steel

Cover material	Polymethylmethacrylate (PMMA)
Light emitting surface material	PMMA
Glow Wire Test according to IEC 60695-2-12	650 °C
Mercury content	0.0 mg

Application & Mounting

Ambient temperature range	-20...+45 °C
Temperature range at storage	-20...+80 °C
Type of connection	Terminal, 3-pin
Type of protection	IP44
Protection class IK (shock resistance)	IK03
Dimmable	No
Mounting type	Surface
Mounting location	Ceiling / Wall
Application environment	Indoor
LED module replaceable	Not replaceable
With light source	Yes

Lifespan

Lifespan L70/B50 at 25 °C	50000 h ¹⁾
Lifespan L80/B10 at 25 °C	45000 h ¹⁾
Lifespan L90/B10 at 25 °C	40000 h
Number of switching cycles	100000

¹⁾ t[h]: L70 / B50 @ 25 °C (Ta), t[h]: L80 / B10 @ 25 °C (Ta), t[h]: L90 / B10 @ 25 °C (Ta)

Control gear

Output current	1000 mA
ECG - Output ripple current	< 20 %

Sensor

Type of sensor	Motion / Light
Sensor technology	Microwave
Sensor detection angle	120 °
Sensor controlled switching time	5 s...30 min
Detection range of motion sensor	4...7 m
Detection threshold of daylight sensor	2...50 lx

Sensor IK rating	IK03
------------------	------

Certificates & Standards

Standards	CE / CB / TÜV / UKCA / EAC / EPD
Luminaire with limited surface temperature, "D sign"	No
Ball shot safe	No
EPD	LEDV-00022-V01.01-EN





Additional product data



Product remark	Available from March 2023
Added function	MULTI SELECT











EQUIPMENT / ACCESSORIES



– Replacement cover optional available

DOWNLOAD DATA

Documents and certificates		Document name
	User Instruction	SF CIRC 500
	Addon Technical Information	LSI SF CIRC 500 42W IP44 PS
	Legal information	Legal Insert SF CIRC SEN V IP44
	Declarations of conformity	SF CIRC 500 SEN
	Declarations Of Conformity UKCA	SF CIRC 500 SEN V

Photometric and lighting design files		Document name
	IES file (IES)	SF CIRC 500 SEN V 42W 830 IP44 PS 1500lm
	LDT file (Eulumdat)	SF CIRC 500 SEN V 42W 830 IP44 PS 1500lm
	ULD file (DIALux)	SF CIRC 500 SEN

Photometric and lighting design files		Document name
	ROLF file (RELUX)	SF CIRC 500 SEN V
	UGR file (UGR table)	SF CIRC 500 SEN V 42W 830 IP44 PS 1500lm
	UGR file (UGR table)	SF CIRC 500 SEN V 42W 830 IP44 PS 2500lm
	UGR file (UGR table)	SF CIRC 500 SEN V 42W 830 IP44 PS 3500lm
	LDC typ cone	SF CIRC 500 SEN V 42W 830 IP44 PS 1500lm
	LDC typ cone	SF CIRC 500 SEN V 42W 830 IP44 PS 2500lm
	LDC typ cone	SF CIRC 500 SEN V 42W 830 IP44 PS 3500lm
	LDC typ polar	SF CIRC 500 SEN V 42W 830 IP44 PS 1500lm
	LDC typ polar	SF CIRC 500 SEN V 42W 830 IP44 PS 2500lm
	LDC typ polar	SF CIRC 500 SEN V 42W 830 IP44 PS 3500lm

CAD/BIM files		Document name
	BIM_Revit_3D	SURFACE CIRCULAR
	CAD_STEP_3D	SF CIRC 500

Tender texts		Document name
	Tender documents	SURFACE CIRCULAR 500 SENSOR PS 42W 830 IP44 PS-EN

LOGISTICAL DATA

Product code	Packaging unit (Pieces/Unit)	Dimensions (length x width x height)	Gross weight	Volume
4099854042157	Folding box 1	112 mm x 527 mm x 534 mm	1672.00 g	31.52 dm ³
4099854042164	Shipping box 5	582 mm x 547 mm x 564 mm	10399.00 g	179.55 dm ³

The mentioned product code describes the smallest quantity unit which can be ordered. One shipping unit can contain one or more single products. When placing an order, for the quantity please enter single or multiples of a shipping unit.

ADDITIONAL CATALOG INFORMATION

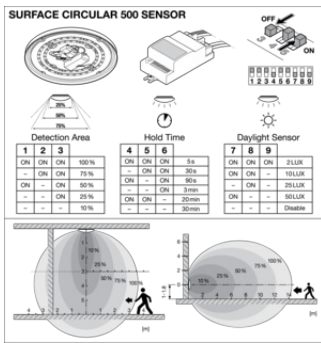
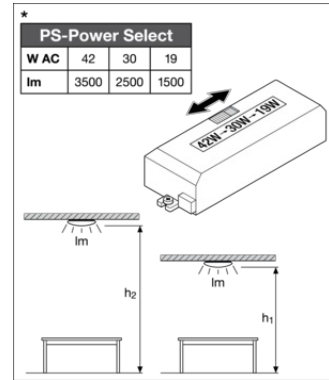
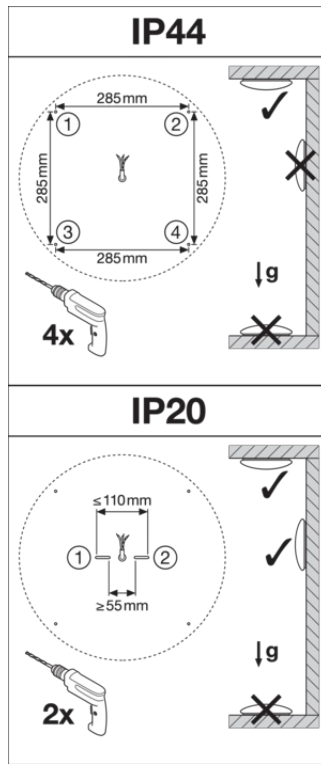
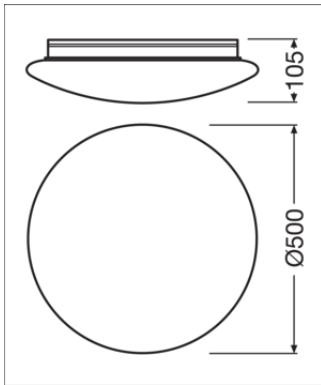

References / Links

- For Guarantee see www.ledvance.com/guarantee

DISCLAIMER

Subject to change without notice. Errors and omission excepted. Always make sure to use the most recent release.