

# PRODUCT DATASHEET

## PL CMFT 600 P 28W 830 DALIVR

PANEL COMFORT 600 DALI | Square recessed panel luminaire, for 600 x 600 mm ceiling systems and DALI-2 IoT technology



### Areas of application

- Direct replacement for recessed luminaires with fluorescent lamps
- Offices, conference rooms
- Reception areas, foyers, corridors, elevators
- Suitable for recessed ceiling systems with grid size of 600 x 600 mm

### Product benefits

- Suitable luminaire for VIVARES and other DALI-2 Light Management Systems
- Tool-free electrical connection due to push button connector
- Through-wiring possible with included connector box
- Energy savings thanks to high system efficacy: up to 130 lm/W
- High color consistency with SDCM 3
- Extended services such as energy monitoring and remote maintenance possible with DALI versions
- External driver for extended flexibility and easy installation
- Low flicker light thanks to special electronic control gear
- Suitable for emergency lighting
- 5 years guarantee

### Product features

- IoT-ready luminaire with DALI-2 technology
- Suitable for central battery emergency installations acc. to EN 60598-2-22



- Push DIM function for dimming and switching directly on a pushbutton
- Extruded aluminum frame
- Polystyrene diffuser
- 5-pole terminal block, cable cross section up to 5 x 2.5 mm<sup>2</sup>
- Lifetime (L80/B10): 70,000 h (at 25 °C)

## TECHNICAL DATA

### Electrical data

Nominal wattage	28.00 W <sup>1)</sup>
Nominal voltage	220...240 V
Mains frequency	0/50/60 Hz
Nominal current	130.000 mA
Inrush current	4.4 A
Inrush current time T <sub>h50</sub>	440 µs
Max. number of luminaires per miniature circuit breaker B16	40
Max. number of luminaires per miniature circuit breaker C10	40
Max. number of luminaires per miniature circuit breaker C16	65
Power factor λ	> 0.90
Total harmonic distortion	< 20 %
Protection class	II
Operating mode	External LED driver

<sup>1)</sup> CRI80 versions of the Panel Comfort family are fulfilling the technical minimum requirements according to the German BEG subsidy program for energy efficient luminaires

### Photometrical data

Luminous flux	3640 lm <sup>1)</sup>
Luminous efficacy	130 lm/W <sup>1)</sup>
Color temperature	3000 K
Light color (designation)	Warm White
Color rendering index Ra	> 80
Standard deviation of color matching	≤3 sdcn
Low flicker	Yes
Flickering metric (Pst LM)	<1
Stroboscope effect metric (SVM)	< 0.4
Photobiological safety group acc. to EN62778	RG0
Beam angle	110 °

<sup>1)</sup> CRI80 versions of the Panel Comfort family are fulfilling the technical minimum requirements according to the German BEG subsidy program for energy efficient luminaires

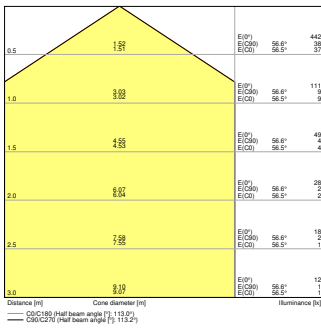

PL CMFT 600 P 28W 830 DALIVR  
EM CONVERSION BOX

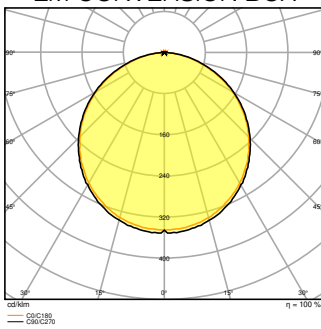

PL CMFT 600 P 28W 830 DALIVR  
EM CONVERSION BOX

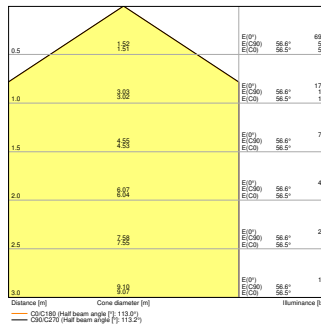

PL CMFT 600 P 28W 830 DALIVR  
EM

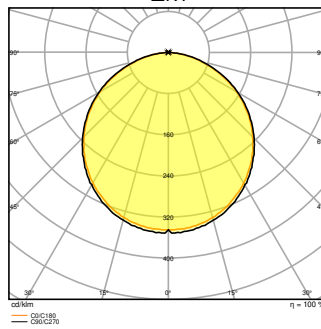

PL CMFT 600 P 28W 830 DALIVR  
EM

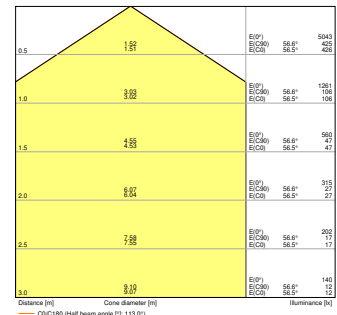

PL CMFT 600 P 28W 830 DALIVR

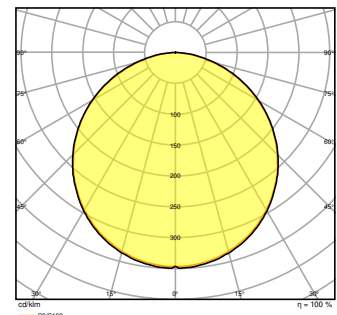

PL CMFT 600 P 28W 830 DALIVR

Dimensions & Weight

Length	595.00 mm
Width	595.00 mm
Height	32.00 mm
Product weight	1860.00 g

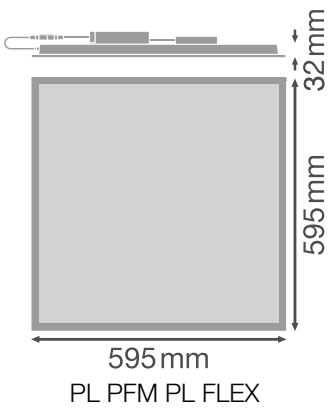

## Materials & Colors

Product color	White
Housing color	White
Body material	Steel
Cover material	Polystyrene (PS)
Light emitting surface material	Polystyrene
Glow Wire Test according to IEC 60695-2-12	650 °C
Mercury content	0.0 mg

## Application & Mounting

Ambient temperature range	-10...+50 °C
Temperature range at storage	-20...+80 °C
Type of connection	Screwless terminal, 5-Pole (L, N, PE, DA+, DA-)
Type of protection	IP40/IP20
Protection class IK (shock resistance)	IK02
Dimmable	Yes
Type of dimming	DALI2
Mounting type	Recessed/Suspended/Surface
Mounting location	Ceiling
Application environment	Indoor
Mounting length	575 mm
Mounting width	575 mm
Mounting depth	50,0 mm
Adjustable	No
LED module replaceable	Not replaceable
With light source	Yes

## Lifespan

Lifespan L70/B50 at 25 °C	100000 h <sup>1)</sup>
Lifespan L80/B10 at 25 °C	70000 h <sup>1)</sup>
Lifespan L90/B10 at 25 °C	48000 h
Number of switching cycles	50000

<sup>1)</sup> t[h]: L70 / B50 @ 25 °C (Ta), t[h]: L80 / B10 @ 25 °C (Ta), t[h]: L90 / B10 @ 25 °C (Ta)

## Control gear

Output current	620 mA
ECG - Output ripple current	< 5 %
ECG - Length	209,00 mm
ECG - Width	42.5 mm
ECG - Height	30 mm
Recommended control gear	OSRAM OTI DALI 50/220-240/1A4 NFC; Tridonic LCA 45W 500-1400mA one4all SC PRE





**Emergency lighting**

Wattage in emergency operation mode	5.5 W
Luminous flux in emergency operation mode	500 lm

**Certificates & Standards**

Standards	CE / CB / ENEC / UKCA / EAC / EPD
Luminaire with limited surface temperature, "D sign"	No
Ball shot safe	No
EPD	LEDV-00011-V01.01-EN

**Accessories Optional**











Product image	Product name	EAN
	EM CONVERSION BOX	4058075237025
	PANEL 600 SURFACE MOUNT KIT H75	4058075472914
	PANEL 600 SURFACE MOUNT KIT H70 VAL	4058075402843
	PANEL RECESSED MOUNT CLIPS VAL 4x	4058075409859











Product image	Product name	EAN
	PANEL Suspension Kit	4058075402928



**EQUIPMENT / ACCESSORIES**

- Accessories for several mounting options available
- Connector box with 5-pole terminal included
- Security rope for luminaire included
- Security brackets preinstalled
- External control gear included
- Suitable for use with separate Emergency Conversion Box

**DOWNLOAD DATA**

Documents and certificates	Document name
 User Instruction	PL CMFT P DALIVR
 Addon Technical Information	LISO Insert Panel CMFT 600 P DALI and 625 P DALI
 Declarations of conformity	CE Declaration PL CMFT DALI
 Declarations of conformity	CE Declaration PL CMFT DALIVR
 Declarations Of Conformity UKCA	UKCA Declaration PL CMFT DALI
 Declarations Of Conformity UKCA	UKCA Declaration PL CMFT DALIVR
 Declarations Of Conformity UKCA	PL COMFT DALIVR
 Declarations Of Conformity UKCA	PL COMFT P DALIVR
Photometric and lighting design files	Document name
 IES file (IES)	PL CMFT 600 P 28W 830 DALIVR
 LDT file (Eulumdat)	PL CMFT 600 P 28W 830 DALIVR

Photometric and lighting design files		Document name
	ULD file (DIALux)	PL CMFT 600 P 28W 830 DALI
	ROLF file (RELUX)	PL CMFT 600 P 28W 830 DALI
	UGR file (UGR table)	PL CMFT 600 P 28W 830 DALIVR EM CONVERSION BOX
	UGR file (UGR table)	PL CMFT 600 P 28W 830 DALIVR EM
	UGR file (UGR table)	PL CMFT 600 P 28W 830 DALIVR
	LDC typ cone	PL CMFT 600 P 28W 830 DALIVR EM CONVERSION BOX
	LDC typ cone	PL CMFT 600 P 28W 830 DALIVR EM
	LDC typ cone	PL CMFT 600 P 28W 830 DALIVR
	LDC typ polar	PL CMFT 600 P 28W 830 DALIVR EM CONVERSION BOX
	LDC typ polar	PL CMFT 600 P 28W 830 DALIVR EM
	LDC typ polar	PL CMFT 600 P 28W 830 DALIVR

CAD/BIM files		Document name
	BIM_Revit_3D	PL_CMFT
	CAD_STEP_3D	PL_CMFT_600

Tender texts		Document name
	Tender documents	PANEL COMFORT 600 DALI 28W 830 DALIVR-EN

**LOGISTICAL DATA**

Product code	Packaging unit (Pieces/Unit)	Dimensions (length x width x height)	Gross weight	Volume
4099854014352	Folding box 1	52 mm x 622 mm x 694 mm	2182.00 g	22.45 dm <sup>3</sup>
4099854014369	Shipping box 4	647 mm x 222 mm x 724 mm	10608.00 g	103.99 dm <sup>3</sup>

The mentioned product code describes the smallest quantity unit which can be ordered. One shipping unit can contain one or more single products. When placing an order, for the quantity please enter single or multiples of a shipping unit.



## ADDITIONAL CATALOG INFORMATION

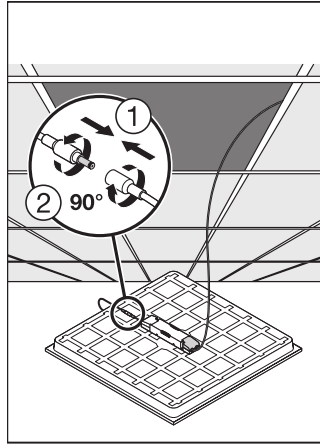
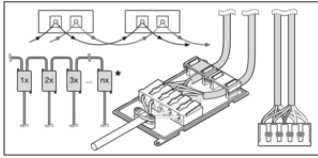

## References / Links

– For Guarantee see [www.ledvance.com/guarantee](http://www.ledvance.com/guarantee)

## DISCLAIMER

Subject to change without notice. Errors and omission excepted. Always make sure to use the most recent release.