

PRODUCT DATASHEET

PANEL 600 IP54 36 W 3000 K OP WT

PANEL 600 IP54 | Square recessed panel luminaires with IP54 protection and high luminous flux, 600 x 600 mm

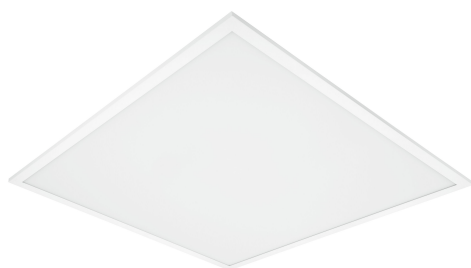

Areas of application

- Direct replacement for luminaires with fluorescent lamps
- Hospitals
- Laboratories
- Suitable for recessed ceiling systems with grid size of 600 x 600 mm
- Kitchens, workspaces

Product benefits

- Suitable for use in dusty and damp locations thanks to high IP rating
- High lumen output reduces the total number of panels per installation
- Energy savings of up to 50 % (compared to luminaires that use fluorescent lamps)
- Low flicker light thanks to special electronic control gear
- 5 years guarantee
- Versions with DALI ECG available

Product features

- Type of protection: IP54
- Luminous flux: up to 4,320 lm
- High luminous efficacy: up to 120 lm/W
- Lifetime (L80/B50): up to 60,000 h (at 25 °C)



– Aluminum housing, PMMA diffuser

TECHNICAL DATA

Electrical data

Nominal wattage	36.00 W
Nominal voltage	220...240 V
Mains frequency	50/60 Hz
Nominal current	190.000 mA
Inrush current	15.0 A
Inrush current time T_{h50}	460 μ s
Max. number of luminaires per miniature circuit breaker B16	17
Max. number of luminaires per miniature circuit breaker C10	35
Max. number of luminaires per miniature circuit breaker C16	56
Power factor λ	> 0.90
Total harmonic distortion	20 %
Protection class	II
Operating mode	External LED driver

Photometrical data

Luminous flux	4320 lm
Luminous efficacy	120 lm/W
Color temperature	3000 K
Light color (designation)	Warm White
Color rendering index Ra	> 80
Standard deviation of color matching	3 sdc _m
Luminous intensity	-
Low flicker	Yes
Flickering metric (Pst LM)	-
Stroboscope effect metric (SVM)	-
Photobiological safety group acc. to EN62778	RG0
Beam angle	120 °

0.5	1.52 1.51	E(0°) 5944 E(C90) 492 E(C0) 504
1.0	3.04 3.01	E(0°) 1486 E(C90) 123 E(C0) 126
1.5	4.57 4.52	E(0°) 660 E(C90) 55 E(C0) 56
2.0	6.09 6.02	E(0°) 372 E(C90) 31 E(C0) 32
2.5	7.61 7.53	E(0°) 238 E(C90) 20 E(C0) 20
3.0	9.13 9.03	E(0°) 165 E(C90) 14 E(C0) 14

Distance [m] Cone diameter [m] Illuminance [lx]

— C0/C180 (Half beam angle [°]: 112.8°)
— C90/C270 (Half beam angle [°]: 113.4°)

Panel 600 36W 3000K OP IP54

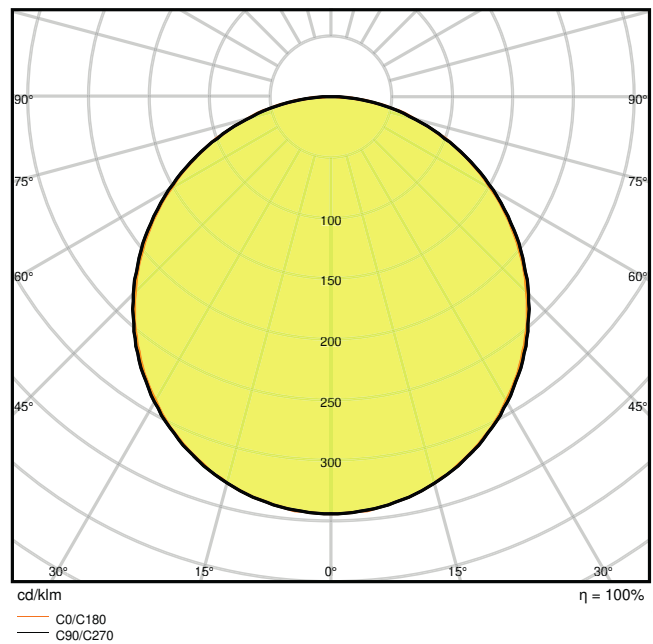

Panel 600 36W 3000K OP IP54

Dimensions & Weight

Length	595.00 mm
Width	595.00 mm
Height	12.60 mm
Product weight	3200.00 g

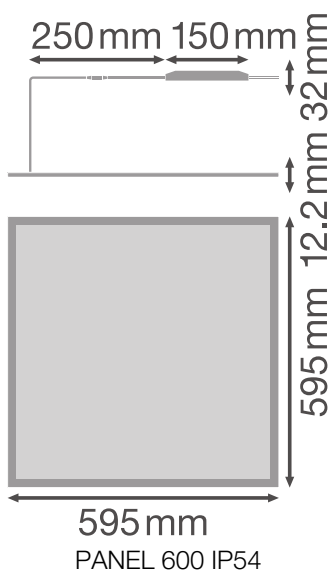

Materials & Colors

Product color	White
Housing color	White
Body material	Steel
Cover material	Polymethylmethacrylate (PMMA)
Light emitting surface material	PMMA
Glow Wire Test according to IEC 60695-2-12	650 °C
Mercury content	0.0 mg

Application & Mounting

Ambient temperature range	-10...+45 °C
Type of connection	Screw terminal, 2-Pole (L,N)
Type of protection	IP54/IP20
Protection class IK (shock resistance)	IK03
Dimmable	No
Mounting type	Recessed/Suspended/Surface
Mounting location	Ceiling / Wall
Application environment	Indoor
Mounting length	575 mm
Mounting width	575 mm
Mounting depth	50,0 mm
LED module replaceable	Not replaceable
With light source	Yes

Lifespan

Lifespan L70/B50 at 25 °C	70000 h ¹⁾
Lifespan L80/B10 at 25 °C	60000 h ¹⁾
Lifespan L90/B10 at 25 °C	35000 h
Number of switching cycles	25000

¹⁾ t[h]: L70 / B50 @ 25 °C (Ta), t[h]: L80 / B10 @ 25 °C (Ta), t[h]: L90 / B10 @ 25 °C (Ta)

Control gear





ECG - Length	150 mm
ECG - Width	41.4 mm

ECG - Height	30 mm
--------------	-------

Certificates & Standards

Standards	CE / CB / ENEC / TÜV SÜD / EAC
Luminaire with limited surface temperature, "D sign"	No
Ball shot safe	No

















Accessories Optional

Product image	Product name	EAN
	CONNECTOR BOX 5POLE L/N 4x	4058075473010
	PANEL RECESSED MOUNT CLIPS VAL 4x	4058075409859
	PANEL 600 RECESSED MOUNT FRAME	4058075402881
	PANEL 600 SURFACE MOUNT KIT H70 VAL	4058075402843
	PANEL 600 SURFACE MOUNT KIT H75	4058075472914
	PANEL Suspension Kit	4058075402928

EQUIPMENT / ACCESSORIES

- Accessories for several mounting options available
- External control gear included

DOWNLOAD DATA

Documents and certificates		Document name
	User Instruction	PL OP IP54
	Addon Technical Information	PL OP IP54
	Legal information	Legal insert DL UGR19 PFM
	Declarations of conformity	Attestation of Conformity Panel 36W OP IP54 TÜV
	Declarations of conformity	Attestation of conformity PANEL
	Declarations of conformity	Declaration of Conformity Panel 600 625 MP OP LEDV
	Declarations Of Conformity UKCA	PANEL 600
	Certificates	Certificates ENEC and TUV PANEL
Photometric and lighting design files		Document name
	IES file (IES)	Panel 600 36W 3000K OP IP54
	LDT file (Eulumdat)	Panel 600 36W 3000K OP IP54
	ULD file (DIALux)	PANEL600IP5436W3000KOPI54WT
	ROLF file (RELUX)	PL 600 34W-3000K
	UGR file (UGR table)	Panel 600 36W 3000K OP IP54
	LDC typ cone	Panel 600 36W 3000K OP IP54
	LDC typ polar	Panel 600 36W 3000K OP IP54
CAD/BIM files		Document name
	BIM_Revit_3D	Panel IP54

Tender texts	Document name
 Tender documents	PANEL 600 IP54 36 W 3000 K OP WT-EN

LOGISTICAL DATA

Product code	Packaging unit (Pieces/Unit)	Dimensions (length x width x height)	Gross weight	Volume
4058075149489	Folding box 1	625 mm x 62 mm x 635 mm	3495.00 g	24.61 dm ³
4058075149496	Shipping box 4	650 mm x 270 mm x 645 mm	14830.00 g	113.20 dm ³

The mentioned product code describes the smallest quantity unit which can be ordered. One shipping unit can contain one or more single products. When placing an order, for the quantity please enter single or multiples of a shipping unit.

ADDITIONAL CATALOG INFORMATION

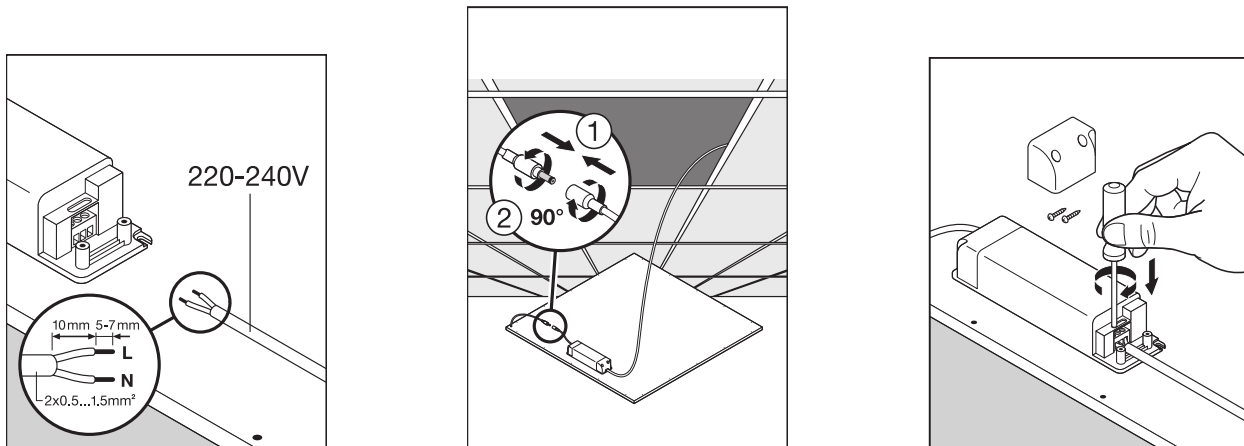

References / Links

– For Guarantee see www.ledvance.com/guarantee

DISCLAIMER

Subject to change without notice. Errors and omission excepted. Always make sure to use the most recent release.