

PRODUCT DATASHEET

PL CMFT 625 P 33W 830 PS

PANEL COMFORT 625 PS | Square recessed panel luminaires with power select (PS) feature, for 625 x 625 mm ceiling systems



Areas of application

- Direct replacement for recessed luminaires with fluorescent lamps
- Offices, conference rooms
- Reception areas, foyers, corridors, elevators
- Suitable for recessed ceiling systems with grid size of 625 x 625 mm

Product benefits

- Highly versatile due to selectable power steps (Power Select - PS) on the driver
- Tool-free electrical connection due to push button connector
- Through-wiring possible with included connector box
- Energy savings thanks to high system efficacy: up to 130 lm/W
- High color consistency with SDCM 3
- Extended services such as energy monitoring and remote maintenance possible with DALI versions
- External driver for extended flexibility and easy installation
- Low flicker light thanks to special electronic control gear
- Emergency lighting possible with LEDVANCE Emergency Conversion Box
- 5 years guarantee

Product features

- Extruded aluminum frame
- Polystyrene diffuser



- 5-pole terminal block, cable cross section up to 5 x 2.5 mm²
- Luminaire versions with IoT-ready DALI-2 driver available
- Lifetime (L80/B10): 70,000 h (at 25 °C)

TECHNICAL DATA

Electrical data

Nominal wattage	33 W / 30 W / 28 W ¹⁾
Nominal voltage	220...240 V
Mains frequency	50...60 Hz
Nominal current	150.000 mA
Inrush current	9 A
Inrush current time T _{h50}	690 µs
Max. number of luminaires per miniature circuit breaker B16	14
Max. number of luminaires per miniature circuit breaker C10	15
Max. number of luminaires per miniature circuit breaker C16	24
Power factor λ	> 0.90
Total harmonic distortion	< 20 %
Protection class	II
Operating mode	External LED driver

¹⁾ For possible options refer to lumen/power table image / CRI80 versions of the Panel Comfort family are fulfilling the technical minimum requirements according to the German BEG subsidy program for energy efficient luminaires

Photometrical data

Luminous flux	4320 lm / 3900 lm / 3640 lm ¹⁾
Luminous efficacy	130 lm/W ¹⁾
Color temperature	3000 K
Light color (designation)	Warm White
Color rendering index Ra	> 80
Standard deviation of color matching	≤3 sdc _m
Low flicker	Yes
Flickering metric (Pst LM)	<1
Stroboscope effect metric (SVM)	< 0.4
Photobiological safety group acc. to EN62778	RG0
Beam angle	110 °

¹⁾ For possible options refer to lumen/power table image / CRI80 versions of the Panel Comfort family are fulfilling the technical minimum requirements according to the German BEG subsidy program for energy efficient luminaires

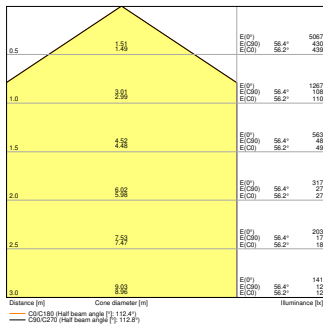

PL CMFT 625 P 28W 830 PS

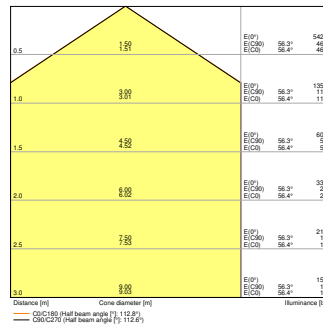
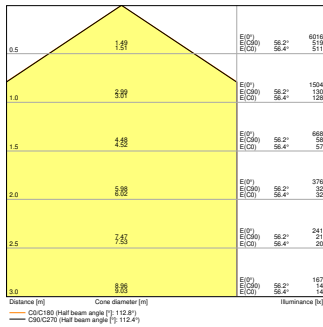

PL CMFT 625 P 30W 830 PS

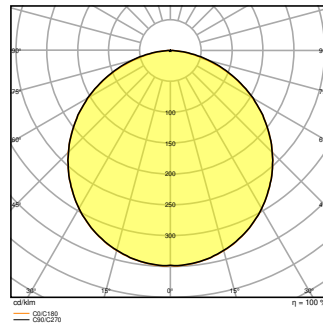

PL CMFT 625 P 28W 830 PS

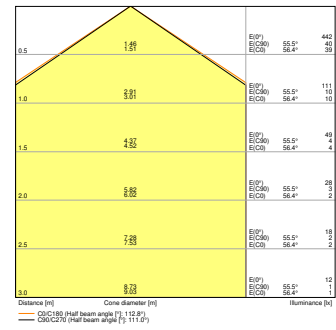

PL CMFT 625 P 33W 830 PS EM
CONVERSION BOX

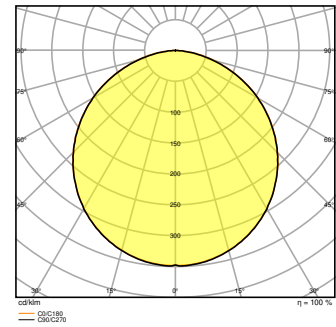

PL CMFT 625 P 30W 830 PS

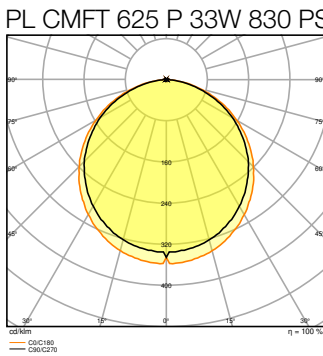

PL CMFT 625 P 33W 830 PS EM
CONVERSION BOX

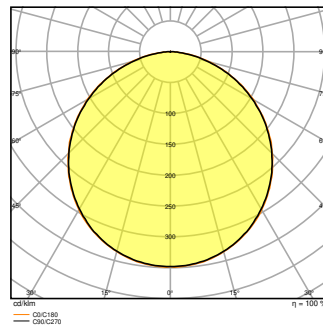

PL CMFT 625 P 33W 830 PS

Dimensions & Weight

Length	620.00 mm
Width	620.00 mm
Height	32.00 mm
Product weight	1820.00 g

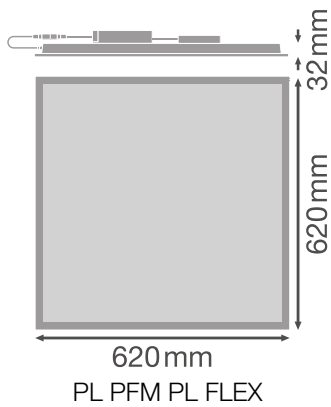

Materials & Colors

Product color	White
Housing color	White
Body material	Aluminum
Cover material	Polystyrene (PS)
Light emitting surface material	Polystyrene
Glow Wire Test according to IEC 60695-2-12	650 °C
Mercury content	0.0 mg

Application & Mounting

Ambient temperature range	-10...+50 °C
Temperature range at storage	-20...+80 °C
Type of connection	Screwless terminal, 5-Pole (L, N, PE, DA+, DA-)
Type of protection	IP40/IP20
Protection class IK (shock resistance)	IK02
Dimmable	No
Mounting type	Recessed/Suspended/Surface
Mounting location	Ceiling
Application environment	Indoor
Mounting length	600,0 mm
Mounting width	600,0 mm
Mounting depth	50,0 mm
Adjustable	No
LED module replaceable	Not replaceable

With light source	Yes
-------------------	-----

Lifespan

Lifespan L70/B50 at 25 °C	100000 h ¹⁾
Lifespan L80/B10 at 25 °C	70000 h ¹⁾
Lifespan L90/B10 at 25 °C	48000 h
Number of switching cycles	50000

¹⁾ t[h]: L70 / B50 @ 25 °C (Ta), t[h]: L80 / B10 @ 25 °C (Ta), t[h]: L90 / B10 @ 25 °C (Ta)

Control gear

Output current	730 mA
ECG - Output ripple current	< 5 %
ECG - Length	143 mm
ECG - Width	49 mm
ECG - Height	30 mm
Recommended control gear	OSRAM OTI DALI 50/220-240/1A4 NFC; Tridonic LCA 45W 500-1400mA one4all SC PRE



Certificates & Standards



Standards	CE / CB / ENEC / UKCA / EAC / EPD
Luminaire with limited surface temperature, "D sign"	No
Ball shot safe	No
EPD	LEDV-00011-V01.01-EN

Additional product data

Added function	MULTI SELECT
----------------	--------------

Accessories Optional







Product image	Product name	EAN
	EM CONVERSION BOX	4058075237025
	PANEL 625 SURFACE MOUNT KIT H70 VAL	4058075402867















Product image	Product name	EAN
	PANEL 625 RECESSED MOUNT FRAME	4058075402904
	PANEL RECESSED MOUNT CLIPS VAL 4x	4058075409859
	PANEL Suspension Kit	4058075402928



EQUIPMENT / ACCESSORIES

- Accessories for several mounting options available
- Connector box with 5-pole terminal included
- Security brackets preinstalled
- External control gear included
- Suitable for use with separate Emergency Conversion Box

DOWNLOAD DATA

Documents and certificates		Document name
	User Instruction	PL CMFT P PS
	Addon Technical Information	LISO Insert Panel CMFT 600 P and 625 P
	Declarations of conformity	CE Declaration PL CMFT PS
	Declarations Of Conformity UKCA	UKCA Declaration PL CMFT PS
Photometric and lighting design files		Document name
	IES file (IES)	PL CMFT 625 P 33W 830 PS
	LDT file (Eulumdat)	PL CMFT 625 P 33W 830 PS

Photometric and lighting design files	Document name
 ULD file (DIALux)	PL CMFT 625 P 33W 830
 ROLF file (RELUX)	PL CMFT 625 P 33W 830
 UGR file (UGR table)	PL CMFT 625 P 28W 830 PS
 UGR file (UGR table)	PL CMFT 625 P 30W 830 PS
 UGR file (UGR table)	PL CMFT 625 P 33W 830 PS EM CONVERSION BOX
 UGR file (UGR table)	PL CMFT 625 P 33W 830 PS
 LDC typ cone	PL CMFT 625 P 28W 830 PS
 LDC typ cone	PL CMFT 625 P 30W 830 PS
 LDC typ cone	PL CMFT 625 P 33W 830 PS EM CONVERSION BOX
 LDC typ cone	PL CMFT 625 P 33W 830 PS
 LDC typ polar	PL CMFT 625 P 28W 830 PS
 LDC typ polar	PL CMFT 625 P 30W 830 PS
 LDC typ polar	PL CMFT 625 P 33W 830 PS EM CONVERSION BOX
 LDC typ polar	PL CMFT 625 P 33W 830 PS

CAD/BIM files	Document name
 BIM_Revit_3D	PL_CMFT
 CAD_STEP_3D	PL_CMFT_625

Tender texts	Document name
 Tender documents	PANEL COMFORT 625 PS 33W 830 PS-EN

LOGISTICAL DATA

Product code	Packaging unit (Pieces/Unit)	Dimensions (length x width x height)	Gross weight	Volume
4099854014642	Folding box 1	52 mm x 647 mm x 719 mm	2247.00 g	24.19 dm ³
4099854014659	Shipping box 4	672 mm x 227 mm x 749 mm	10213.00 g	114.26 dm ³

The mentioned product code describes the smallest quantity unit which can be ordered. One shipping unit can contain one or more single products. When placing an order, for the quantity please enter single or multiples of a shipping unit.

ADDITIONAL CATALOG INFORMATION

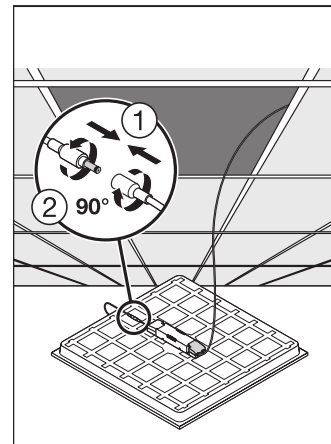
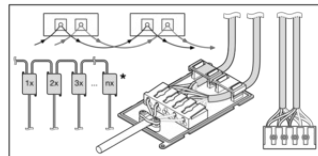
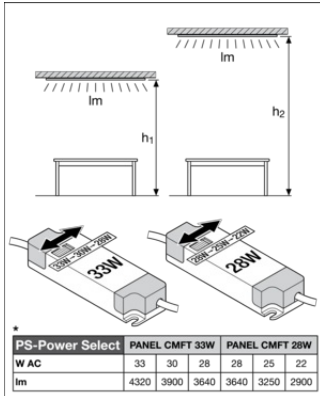

References / Links

– For Guarantee see www.ledvance.com/guarantee

DISCLAIMER

Subject to change without notice. Errors and omission excepted. Always make sure to use the most recent release.