

PRODUCT DATASHEET

DP HOUSING DALI 1500 P 1XLAMP IP65

DAMP PROOF HOUSING DALI | Damp-proof luminaire for dimmable LED TUBE



Areas of application

- Parking lots, warehouses, production areas
- Dimmable installations
- Car parks and underpasses
- Garages

Product benefits

- Easy and quick installation
- Prewired for easy installation of LED TUBE T8 EXTERNAL SYSTEM
- Toolless installation
- Robust housing
- Sustainable solution thanks to exchangeable light sources
- 5 years guarantee

Product features

- Luminaire housing, available for 1 or 2 T8 LED tubes
- Dimmable EXTERNAL SYSTEM Driver is already installed
- Suitable for LEDVANCE LED TUBE T8 EXTERNAL SYSTEM
- DALI 2.0 interface for light management system integration
- Integrated electrical fuse
- Type of protection: IP65



TECHNICAL DATA

Electrical data

Nominal voltage	220...240 V
Mains frequency	0/50/60 Hz
Protection class	I
Operating mode	Integrated LED driver

Photometrical data

Flickering metric (Pst LM)	< 1
Stroboscope effect metric (SVM)	< 0.4

Dimensions & Weight

Length	1585.00 mm
Width	65.00 mm
Height	70.00 mm
Product weight	1110.00 g

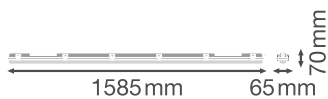

DP HOUSING 1500 P 1XLAMP
IP65

Materials & Colors

Product color	Gray
Housing color	Gray
Body material	Polycarbonate (PC)
Cover material	Polycarbonate (PC)
Light emitting surface material	Polycarbonate (PC)
Glow Wire Test according to IEC 60695-2-12	850 °C

Mercury content	0.0 mg
-----------------	--------

Application & Mounting

Ambient temperature range	-20...+40 °C
Temperature range at storage	-20...+80 °C
Type of connection	Screwless terminal, 5-Pole (L, N, PE, DA+, DA-)
Type of protection	IP65
Protection class IK (shock resistance)	IK08
Dimmable	Yes
Type of dimming	DALI2
Mounting type	Surface
Mounting location	Ceiling
Application environment	Indoor
With light source	No
Holder designation	G13

Control gear

ECG - Output ripple current	≤ 5 %
-----------------------------	-------



Certificates & Standards

Standards	CE / TÜV Rheinland / EAC / UKCA
Luminaire with limited surface temperature, "D sign"	No
Ball shot safe	No



EQUIPMENT / ACCESSORIES

- Through-wiring cable kit available
- Stainless steel clamps and M20 cable gland included

DOWNLOAD DATA

	Documents and certificates	Document name
	User Instruction	UI DP HOUSING DALI
	Legal information	LN INV DALI
	Declarations of conformity	CE Declaration DP HOUSING

Documents and certificates		Document name
	Declarations Of Conformity UKCA	UKCA Declaration DP HOUSING

CAD/BIM files		Document name
	BIM_Revit_3D	Damp Proof Housing G3
	CAD_STEP_3D	DP HOUSING G3 1 1500

Tender texts		Document name
	Tender documents	DAMP PROOF HOUSING DALI 1500 P 1XLAMP IP65-EN

LOGISTICAL DATA

Product code	Packaging unit (Pieces/Unit)	Dimensions (length x width x height)	Gross weight	Volume
4099854146480	Folding box 1	68 mm x 1,577 mm x 75 mm	1280.00 g	8.04 dm ³
4099854146497	Shipping box 6	1,592 mm x 216 mm x 162 mm	8330.00 g	55.71 dm ³
4099854246050	Shipping box 9	1,592 mm x 216 mm x 237 mm	12170.00 g	81.50 dm ³

The mentioned product code describes the smallest quantity unit which can be ordered. One shipping unit can contain one or more single products. When placing an order, for the quantity please enter single or multiples of a shipping unit.

ADDITIONAL CATALOG INFORMATION

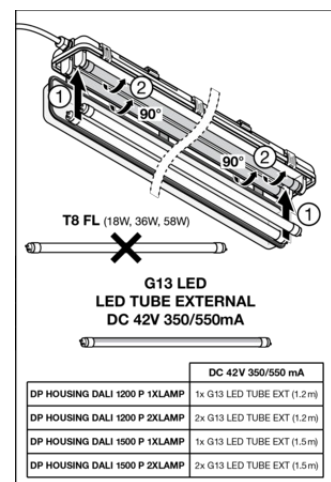
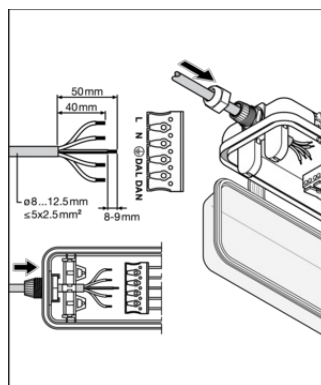
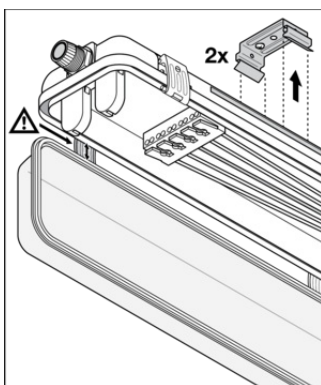

References / Links

– For Guarantee see www.ledvance.com/guarantee

DISCLAIMER

Subject to change without notice. Errors and omission excepted. Always make sure to use the most recent release.