

PRODUCT DATASHEET

TRUSYS FLEX P 70W 840 DS CL WT EM

TruSys® FLEX EMERGENCY DOUBLE ASYMMETRIC | Luminaire inserts with double asymmetric light distribution for standard and emergency lighting, up to 175 lm/W

Areas of application

- Emergency illumination of escape routes
- Antipanic lighting
- Buildings requiring up to 3 h emergency light operation
- Direct replacement for luminaires with fluorescent lamps
- Industry halls, high rack warehouse, hardware stores



Product benefits

- Seamless integration of luminaires with emergency lighting function into general lighting
- Easy wiring thanks to included prewired driver and battery for Emergency lighting function
- Simple testing of luminaires with emergency lighting function thanks to integrated automatic test function
- Convenient visualization of results of automatic test with an included control LED
- Operation of integrated emergency lighting function with long life LiFePO4 battery with 3h battery discharge time
- High luminous efficacy in normal operation
- 3 years guarantee
- Double directed light distribution for shelf illumination
- Easy installation, no tools required for connection
- Energy saving and cost-effective
- Flexible application due to a range of different lumen packages and beam angles

Product features

- Certified according to European norms (EN 60598-1:2015; EN 60598-2-22:2014)



- Luminaire suited for normal lighting and emergency lighting
- Self-contained luminaires
- Emergency lighting function: battery discharge time of 3 h
- Function test of emergency lighting: automatic (AT)
- Battery technology: LiFePO4
- Beam angle double asymmetric: 2x30°
- Click into place solution with smart click buttons
- Fixed luminaire taps
- Steel-sheet housing

TECHNICAL DATA

Electrical data

Nominal wattage	70.00 W
Nominal voltage	220...240 V
Mains frequency	50...60 Hz
Nominal current	320 mA
Inrush current	38.8 A
Inrush current time T_{h50}	230 μ s
Max. number of luminaires per miniature circuit breaker B16	8
Max. number of luminaires per miniature circuit breaker C10	7
Max. number of luminaires per miniature circuit breaker C16	12
Power factor λ	≥ 0.95
Total harmonic distortion	$\leq 15\%$
Protection class	I
Operating mode	Integrated LED driver

Photometrical data

Luminous flux	12100 lm
Luminous efficacy	175 lm/W
Color temperature	4000 K
Light color (designation)	Cool White
Color rendering index Ra	≥ 80
Standard deviation of color matching	3 sdc _m
Low flicker	Yes
Photobiological safety group acc. to EN62778	RG1
Beam angle	2 x 30 °

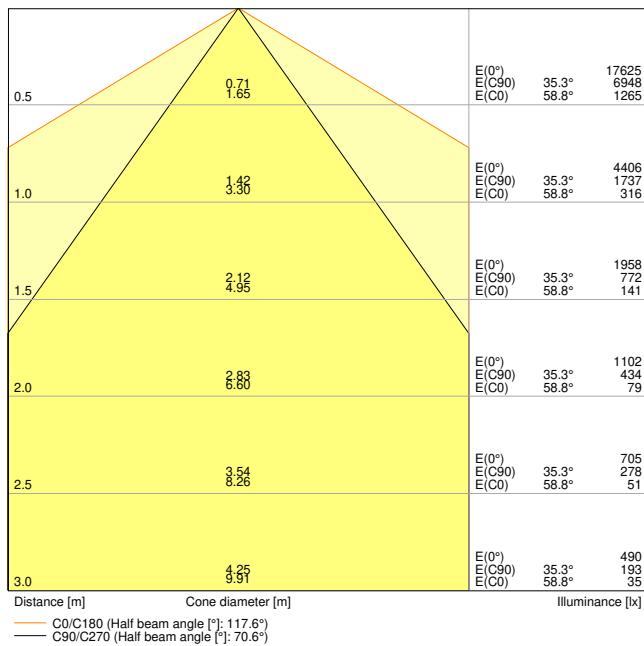

TRUSYS FLEX P 70W 840 DS CL WT EM

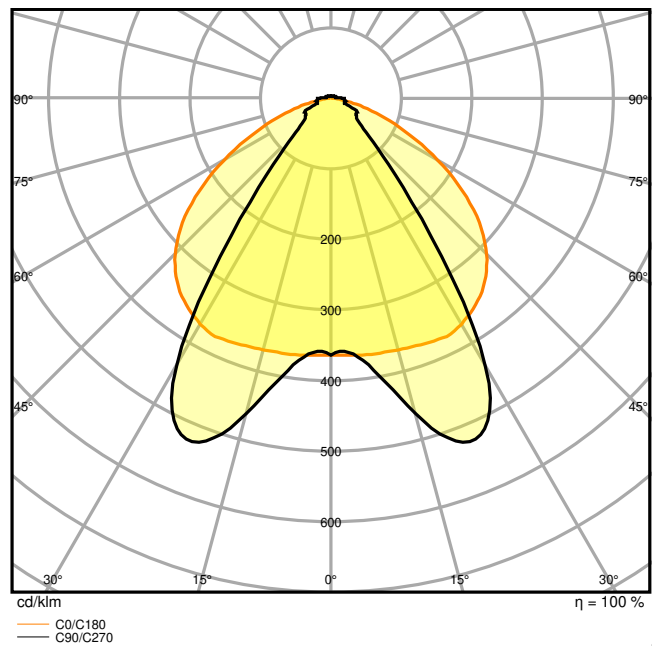

TRUSYS FLEX P 70W 840 DS CL WT EM

Dimensions & Weight

Length	1500.00 mm
Width	77.70 mm
Height	39.40 mm
Product weight	2360.00 g

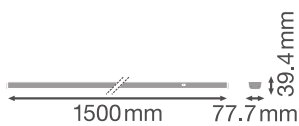

TRUSYS FLEX luminaire - clear

Materials & Colors

Product color	White
Housing color	White
Body material	Steel
Cover material	Polymethylmethacrylate (PMMA)
Light emitting surface material	Polymethylmethacrylate (PMMA)
Glow Wire Test according to IEC 60695-2-12	650 °C
Mercury content	0.0 mg

Application & Mounting

Ambient temperature range	0...+40 °C
Temperature range at storage	-40...+80 °C
Type of connection	Plug-In connection
Type of protection	IP40
Protection class IK (shock resistance)	IK04
Dimmable	No
Mounting type	Suspended/Surface
Mounting location	Mounting rail
Application environment	Indoor
Adjustable	No
LED module replaceable	Not replaceable
With light source	Yes

Lifespan

Lifespan L70/B50 at 25 °C	100000 h ¹⁾
Lifespan L80/B10 at 25 °C	76000 h ¹⁾
Lifespan L90/B10 at 25 °C	38000 h
Number of switching cycles	100000

¹⁾ t[h]: L70 / B50 @ 25 °C (Ta), t[h]: L80 / B10 @ 25 °C (Ta), t[h]: L90 / B10 @ 25 °C (Ta)

Control gear

Output current	1000 mA
ECG - Output ripple current	< 5 %

BATTERY

Type of Battery	LiFePO4
Battery size [GMS]	Others

Nominal voltage of battery	3.2 V
Nominal capacity of battery	9000 mAh
Battery charging time	24 h

Emergency lighting

Area of emergency application	Anti-panic lighting / Escape route lighting
Type of emergency light operation	Non-maintained / Maintained
Type of emergency operation test	Automatic
Wattage in maintained operation mode	70 W
Wattage in emergency operation mode	4 W
Luminous flux in maintained operation mode	12100 lm
Luminous flux in emergency operation mode	740 lm
Battery life in emergency operation mode	3 h







Certificates & Standards











Standards	CE / CB / UKCA / ENEC / EAC
Luminaire with limited surface temperature, "D sign"	Yes
Ball shot safe	No

EQUIPMENT / ACCESSORIES

– Mounting rail with fixed integrated 8-pole cable

DOWNLOAD DATA

	Documents and certificates	Document name
	User Instruction	UI TRUSYS FLEX P EM
	User Instruction	TRUSYS FLEX EMERGENCY 840
	Addon Technical Information	Light Source Insert Trusys Flex EM
	Legal information	Legal insert TRUSYS FLEX P EM
	Declarations of conformity	CE Declaration Trusys Flex P EM
	Declarations Of Conformity UKCA	UKCA Declaration Trusys Flex P EM

Documents and certificates		Document name
	Certificates	ENEC TRUSYS FLEX P EM
Photometric and lighting design files		Document name
	IES file (IES)	TRUSYS FLEX P 70W 840 DS CL WT EM
	LDT file (Eulumdat)	TRUSYS FLEX P 70W 840 DS CL WT EM
	ULD file (DIALux)	TRUSYS FLEX P 70W 840
	ROLF file (RELUX)	TRUSYS FLEX P 70W 840 DS
	UGR file (UGR table)	TRUSYS FLEX P 70W 840 DS CL WT EM
	LDC typ cone	TRUSYS FLEX P 70W 840 DS CL WT EM
	LDC typ polar	TRUSYS FLEX P 70W 840 DS CL WT EM
CAD/BIM files		Document name
	BIM_Revit_3D	TRUSYS FLEX
	CAD_STEP_3D	TruSys FLEX
Tender texts		Document name
	Tender documents	TruSys FLEX EMERGENCY DOUBLE ASYMMETRIC 70W 840 DS CL WT EM-EN

LOGISTICAL DATA

Product code	Packaging unit (Pieces/Unit)	Dimensions (length x width x height)	Gross weight	Volume
4058075773295	Folding box 1	108 mm x 1,534 mm x 102 mm	2535.00 g	16.90 dm ³
4058075773301	Shipping box 4	1,547 mm x 218 mm x 231 mm	10933.00 g	77.90 dm ³

The mentioned product code describes the smallest quantity unit which can be ordered. One shipping unit can contain one or more single products. When placing an order, for the quantity please enter single or multiples of a shipping unit.

ADDITIONAL CATALOG INFORMATION

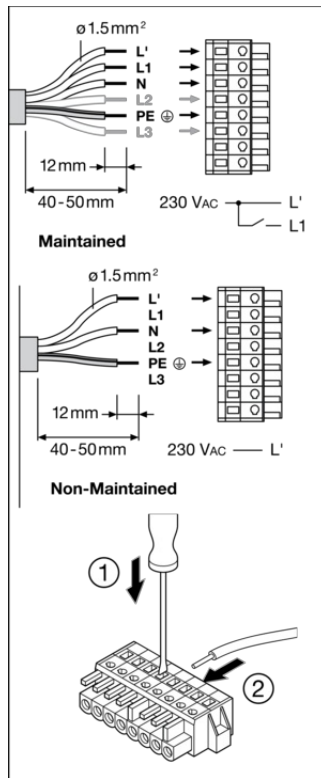

Luminaire Status	Control LED
Normal	Green
Emergency	OFF
Testing	Green: (1s, 1s, 1s ...)
Battery connection fault	Red: (1s, 1s, 1s ...)
Battery capacity fault	Red
Luminaire fault	Red: (4s, 4s, 4s ...)

Test	Icon	Frequency
Initialization		48h Normal Automatic
Daily check of Control LED		Green
Monthly/Weekly functional test (EN 50178)		30s Automatic test once every 7 days
Yearly duration test (EN 50179)		12h Automatic test once every 12 weeks

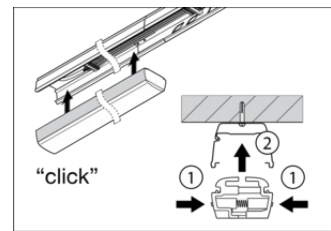
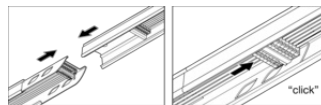

References / Links

– For Guarantee see www.ledvance.com/guarantee

DISCLAIMER

Subject to change without notice. Errors and omission excepted. Always make sure to use the most recent release.