

PRODUCT DATASHEET

LN INV DI 1500 P 69W 930 PS WT

LINEAR INDIVILED DIRECT/INDIRECT 1500 PS | Pendant luminaire for single or light line office application with CRI90 and power select (PS) feature, 1500 mm



Areas of application

- Direct replacement for luminaires with fluorescent lamps
- Offices, education, public buildings
- Single and continuous line configuration
- Direct and indirect lighting

Product benefits

- Easy upgradeability of light source and driver (EVERLOOP design)
- Homogenous light distribution and reduced glare ($UGR \leq 19$) thanks to IndiviLED® optics
- Pendant luminaires with direct light emission (70%) and indirect light emission (30%)
- High performance with CRI90 and up to 134 lm/W
- Highly versatile due to selectable power steps (Power Select - PS) on the driver
- High color consistency with SDCM 3
- Easy installation
- Low flicker light thanks to special electronic control gear
- Multiple mounting options thanks to different accessories
- 5 years guarantee

Product features

- Minimalistic LEDVANCE SCALE design in extruded aluminum housing
- Includes EVERLOOP: Convenient replacement of light source and LED driver



- Linkable into seamless light line with accessories (surface or pendant mounting)
- Pendant mounting with suspension kit (to be ordered separately)
- Glow Wire Test according to IEC 60695-2-12: 850 °C
- 5-pole terminal block, cable cross section up to 5 x 2.5 mm²
- Lifetime (L80/B10): 70,000 h (at 25 °C)

TECHNICAL DATA

Electrical data

Nominal wattage	69 W / 63 W / 61 W / 53 W
Nominal voltage	220...240 V
Mains frequency	50...60 Hz
Nominal current	315...285...270...242 mA
Inrush current	23.6 A
Inrush current time T_{h50}	176 μ s
Max. number of luminaires per miniature circuit breaker B16	17
Max. number of luminaires per miniature circuit breaker C10	14
Max. number of luminaires per miniature circuit breaker C16	23
Power factor λ	≥ 0.90
Total harmonic distortion	≤ 20 %
Protection class	I
Operating mode	Integrated LED driver

Photometrical data

Luminous flux	8350 lm / 7800 lm / 7600 lm / 6650 lm
Luminous efficacy	116 lm/W / 118 lm/W / 121 lm/W
Color temperature	3000 K
Light color (designation)	Warm White
Color rendering index Ra	90
Standard deviation of color matching	3 sdc _m
Low flicker	Yes
Flickering metric (Pst LM)	≤ 1
Stroboscope effect metric (SVM)	≤ 0.4
Photobiological safety group acc. to EN62778	RG0
Photobiological safety group acc. to EN62471	RG0
Beam angle	90 ° + 130 °
UGR	< 19

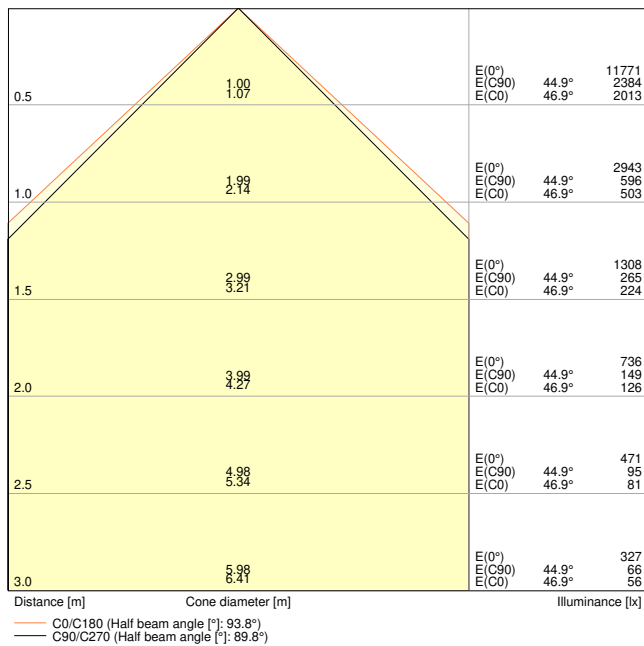

LN INV DI 1500 P 69W 930 PS WT 1400mA

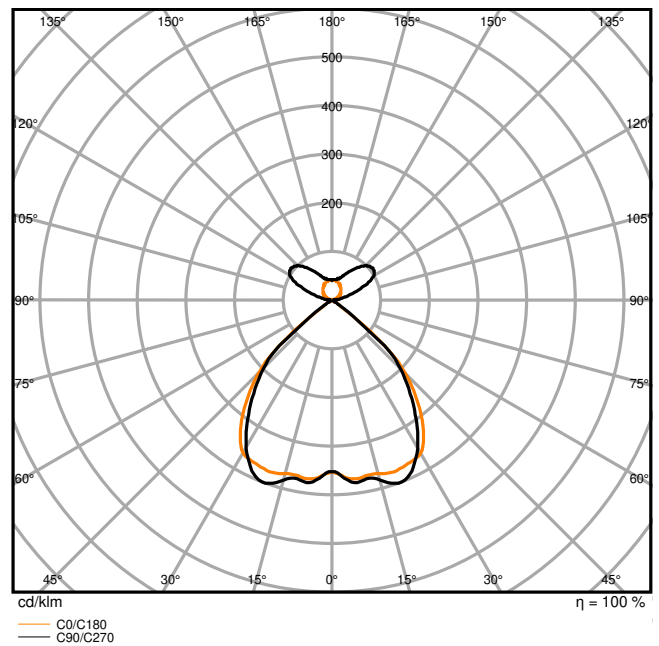

LN INV DI 1500 P 69W 930 PS WT 1400mA

Dimensions & Weight

Length	1475.00 mm
Width	125.00 mm
Height	43.00 mm
Product weight	4300.00 g

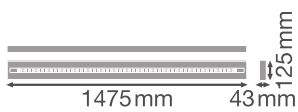

LN INV 1500 P

Materials & Colors

Product color	White
Housing color	White
Body material	Aluminum
Cover material	Polymethylmethacrylate (PMMA)
Light emitting surface material	Polymethylmethacrylate (PMMA)
Glow Wire Test according to IEC 60695-2-12	850 °C
Mercury content	0.0 mg

Application & Mounting

Ambient temperature range	-20...+50 °C
Temperature range at storage	-20...+80 °C
Type of connection	Screwless terminal, 5-Pole (L, N, PE, DA+, DA-)
Type of protection	IP20
Protection class IK (shock resistance)	IK06
Dimmable	No
Mounting type	Suspended
Mounting location	Ceiling
Application environment	Indoor
Adjustable	No
LED module replaceable	By the end consumer
With light source	Yes

Lifespan

Lifespan L70/B50 at 25 °C	100000 h ¹⁾
Lifespan L80/B10 at 25 °C	70000 h ¹⁾
Lifespan L90/B10 at 25 °C	35000 h
Number of switching cycles	25000

¹⁾ t[h]: L70 / B50 @ 25 °C (Ta), t[h]: L80 / B10 @ 25 °C (Ta), t[h]: L90 / B10 @ 25 °C (Ta)

Control gear

Output current	1050 mA
ECG - Output ripple current	≤ 5 %
Recommended control gear	OSRAM type OT FIT 55/220–240/1A0 CS L AP& IT FIT 18/220... 240/350 CS L

Certificates & Standards

Standards	CE / CB / ENEC / TÜV SÜD / UKCA / EAC
-----------	---------------------------------------

Luminaire with limited surface temperature, "D sign"	No
Ball shot safe	No





Additional product data







Number of illuminants	2
Added function	EVERLOOP / MULTI SELECT



EQUIPMENT / ACCESSORIES

- Suspension kit available for pendant luminaire version (to be ordered separately)
- Inline, corner and infill connectors available as separate accessory
- Through-wiring cable kit available

DOWNLOAD DATA

Documents and certificates		Document name
	User Instruction	LN INV
	Addon Technical Information	LSI LN INDIVILED
	Legal information	LN INV PS
	Declarations of conformity	LN INV
	Declarations Of Conformity UKCA	LN INV

Photometric and lighting design files		Document name
	IES file (IES)	LN INV DI 1500 P 69W 930 PS WT 1400mA
	LDT file (Eulumdat)	LN INV DI 1500 P 69W 930 PS WT 1400mA
	ULD file (DIALux)	LN INV DI 1500 P 69W 930 PS WT
	ROLF file (RELUX)	LN INV DI 1500 P 69W 930 PS WT
	UGR file (UGR table)	LN INV DI 1500 P 69W 930 PS WT 1400mA
	LDC typ cone	LN INV DI 1500 P 69W 930 PS WT 1400mA

Photometric and lighting design files		Document name
	LDC typ polar	LN INV DI 1500 P 69W 930 PS WT 1400mA
CAD/BIM files		Document name
	CAD_STEP_3D	LN INV D I 1500 G2.
Tender texts		Document name
	Tender documents	LINEAR INDIVILED DIRECTINDIRECT 1500 PS 1500 P 69W 930 PS WT-EN

LOGISTICAL DATA

Product code	Packaging unit (Pieces/Unit)	Dimensions (length x width x height)	Gross weight	Volume
4099854135231	Folding box 1	1,252 mm x 167 mm x 87 mm	5000.00 g	18.19 dm ³
4099854135248	Shipping box 2	1,547 mm x 187 mm x 189 mm	11600.00 g	54.68 dm ³

The mentioned product code describes the smallest quantity unit which can be ordered. One shipping unit can contain one or more single products. When placing an order, for the quantity please enter single or multiples of a shipping unit.

ADDITIONAL CATALOG INFORMATION

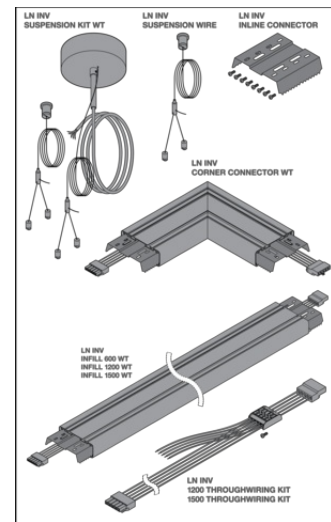
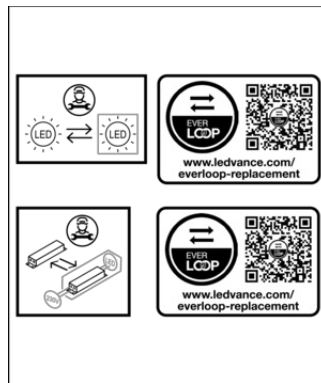
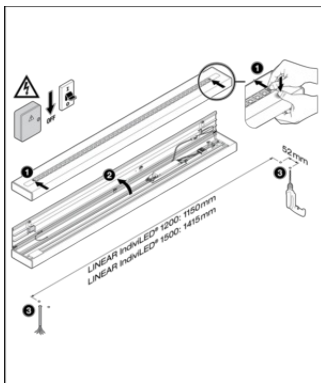

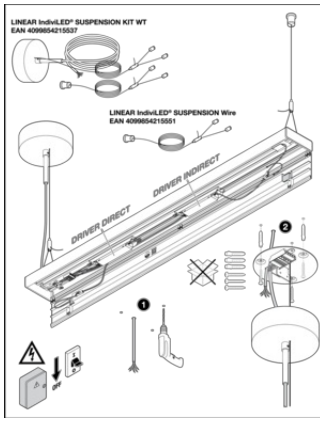

LINEAR InduLED® SUSPENSION KIT WT EAN 409954215037	DRIVER		Preset: ON/OFF		Type	
	Part No.	Part Name	Part No.	Part Name	Part No.	Part Name
LN 1500 P 69W PS WT	LN 1500 P 69W PS WT	LN 1500 P 69W PS WT	LN 1500 P 69W PS WT	LN 1500 P 69W PS WT	LN 1500 P 69W PS WT	LN 1500 P 69W PS WT
LN 1500 P 69W PS WT	LN 1500 P 69W PS WT	LN 1500 P 69W PS WT	LN 1500 P 69W PS WT	LN 1500 P 69W PS WT	LN 1500 P 69W PS WT	LN 1500 P 69W PS WT
LN 1500 P 69W PS WT	LN 1500 P 69W PS WT	LN 1500 P 69W PS WT	LN 1500 P 69W PS WT	LN 1500 P 69W PS WT	LN 1500 P 69W PS WT	LN 1500 P 69W PS WT
LN 1500 P 69W PS WT	LN 1500 P 69W PS WT	LN 1500 P 69W PS WT	LN 1500 P 69W PS WT	LN 1500 P 69W PS WT	LN 1500 P 69W PS WT	LN 1500 P 69W PS WT
LN 1500 P 69W PS WT	LN 1500 P 69W PS WT	LN 1500 P 69W PS WT	LN 1500 P 69W PS WT	LN 1500 P 69W PS WT	LN 1500 P 69W PS WT	LN 1500 P 69W PS WT
LN 1500 P 69W PS WT	LN 1500 P 69W PS WT	LN 1500 P 69W PS WT	LN 1500 P 69W PS WT	LN 1500 P 69W PS WT	LN 1500 P 69W PS WT	LN 1500 P 69W PS WT
LN 1500 P 69W PS WT	LN 1500 P 69W PS WT	LN 1500 P 69W PS WT	LN 1500 P 69W PS WT	LN 1500 P 69W PS WT	LN 1500 P 69W PS WT	LN 1500 P 69W PS WT
LN 1500 P 69W PS WT	LN 1500 P 69W PS WT	LN 1500 P 69W PS WT	LN 1500 P 69W PS WT	LN 1500 P 69W PS WT	LN 1500 P 69W PS WT	LN 1500 P 69W PS WT



References / Links

– For Guarantee see www.ledvance.com/guarantee

DISCLAIMER

Subject to change without notice. Errors and omission excepted. Always make sure to use the most recent release.