

PRODUCT DATASHEET

LN INV D 1500 P 52W 940 PS WT

LINEAR INDIVILED DIRECT 1500 PS | Surface mounted luminaire for single or light line office application with CRI90 and power select (PS) feature, 1500 mm



Areas of application

- Direct replacement for luminaires with fluorescent lamps
- Offices, education, public buildings
- Single and continuous line configuration
- Direct lighting

Product benefits

- Easy upgradeability of light source and driver (EVERLOOP design)
- Homogenous light distribution and reduced glare ($UGR \leq 19$) thanks to IndiviLED® optics
- High performance with CRI90 and up to 130 lm/W
- Highly versatile due to selectable power steps (Power Select - PS) on the driver
- Symmetric and asymmetric light distribution for various application areas
- High color consistency with SDCM 3
- Easy installation
- Low flicker light thanks to special electronic control gear
- Multiple mounting options thanks to different accessories
- 5 years guarantee

Product features

- Minimalistic LEDVANCE SCALE design in extruded aluminum housing
- Includes EVERLOOP: Convenient replacement of light source and LED driver



- Linkable into seamless light line with accessories (surface or pendant mounting)
- Pendant mounting with suspension kit (to be ordered separately)
- Glow Wire Test according to IEC 60695-2-12: 850 °C
- 5-pole terminal block, cable cross section up to 5 x 2.5 mm²
- Lifetime (L80/B10): 70,000 h (at 25 °C)

TECHNICAL DATA

Electrical data

Nominal wattage	52 W / 48 W / 46.0 W / 40 W
Nominal voltage	220...240 V
Mains frequency	50...60 Hz
Nominal current	240...220...205...185 mA
Inrush current	14.6 A
Inrush current time T_{h50}	170 μ s
Max. number of luminaires per miniature circuit breaker B16	28
Max. number of luminaires per miniature circuit breaker C10	23
Max. number of luminaires per miniature circuit breaker C16	38
Power factor λ	≥ 0.90
Total harmonic distortion	≤ 20 %
Protection class	I
Operating mode	Integrated LED driver

Photometrical data

Luminous flux	6360 lm / 5920 lm / 5900 lm / 5200 lm
Luminous efficacy	126 lm/W / 127 lm/W / 128 lm/W / 130 lm/W
Color temperature	4000 K
Light color (designation)	Cool White
Color rendering index Ra	90
Standard deviation of color matching	3 sdc _m
Low flicker	Yes
Flickering metric (Pst LM)	≤ 1
Stroboscope effect metric (SVM)	≤ 0.4
Photobiological safety group acc. to EN62778	RG0
Photobiological safety group acc. to EN62471	RG0
Beam angle	90 °
UGR	< 19

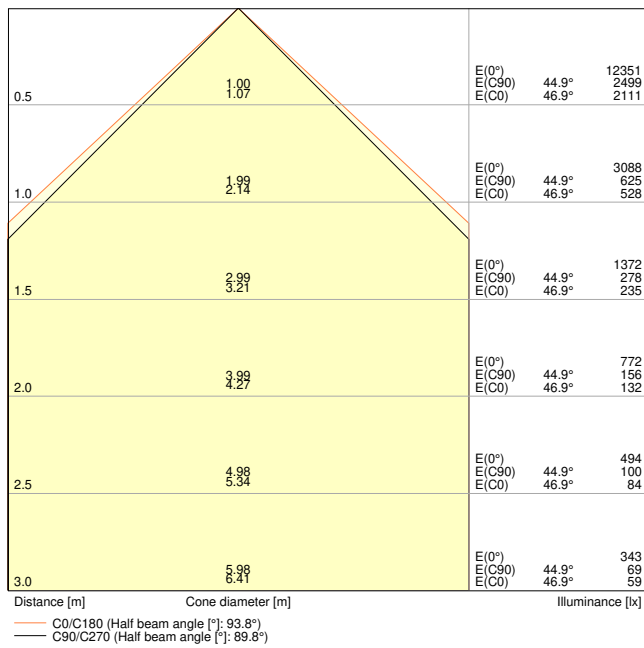

LN INV D 1500 P 52W 940 PS WT 1050mA

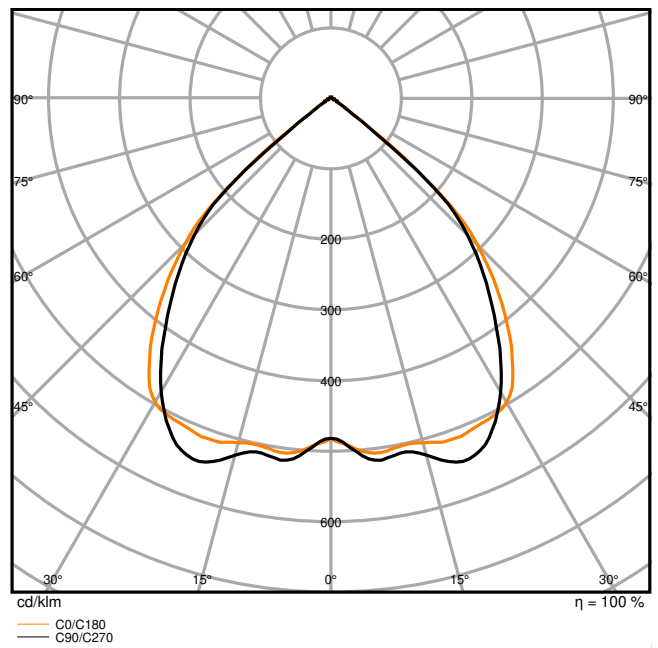

LN INV D 1500 P 52W 940 PS WT 1050mA

Dimensions & Weight

Length	1475.00 mm
Width	125.00 mm
Height	43.00 mm
Product weight	3960.00 g

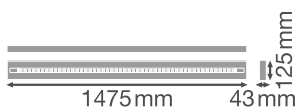

LN INV 1500 P

Materials & Colors

Product color	White
Housing color	White
Body material	Aluminum
Cover material	Polymethylmethacrylate (PMMA)
Light emitting surface material	Polymethylmethacrylate (PMMA)
Glow Wire Test according to IEC 60695-2-12	850 °C
Mercury content	0.0 mg

Application & Mounting

Ambient temperature range	-20...+50 °C
Temperature range at storage	-20...+80 °C
Type of connection	Screwless terminal, 5-Pole (L, N, PE, DA+, DA-)
Type of protection	IP20
Protection class IK (shock resistance)	IK06
Dimmable	No
Mounting type	Suspended/Surface
Mounting location	Ceiling
Application environment	Indoor
Adjustable	No
LED module replaceable	By the end consumer
With light source	Yes

Lifespan

Lifespan L70/B50 at 25 °C	100000 h ¹⁾
Lifespan L80/B10 at 25 °C	70000 h ¹⁾
Lifespan L90/B10 at 25 °C	35000 h
Number of switching cycles	25000

¹⁾ t[h]: L70 / B50 @ 25 °C (Ta), t[h]: L80 / B10 @ 25 °C (Ta), t[h]: L90 / B10 @ 25 °C (Ta)

Control gear

Output current	1050 mA
ECG - Output ripple current	≤ 5 %
Recommended control gear	OSRAM OT FIT 55/220-240/1A0 CS L AP

Certificates & Standards

Standards	CE / CB / ENEC / TÜV SÜD / UKCA / EAC
-----------	---------------------------------------

Luminaire with limited surface temperature, "D sign"	No
Ball shot safe	No







Additional product data





Number of illuminants	1
Added function	EVERLOOP / MULTI SELECT





EQUIPMENT / ACCESSORIES

- Suspension kit available for pendant luminaire version (to be ordered separately)
- Inline, corner and infill connectors available as separate accessory
- Through-wiring cable kit available

DOWNLOAD DATA

Documents and certificates		Document name
	User Instruction	LN INV
	Addon Technical Information	LSI LN INDIVILED
	Legal information	LN INV PS
	Declarations of conformity	LN INV
	Declarations Of Conformity UKCA	LN INV
	Certificates	CEE Eligibility Attestation BAT-EQ-127 FR

Photometric and lighting design files		Document name
	IES file (IES)	LN INV D 1500 P 52W 940 PS WT 1050mA
	LDT file (Eulumdat)	LN INV D 1500 P 52W 940 PS WT 1050mA
	ULD file (DIALux)	LN INV D 1500 P 52W 940 PS WT
	ROLF file (RELUX)	LN INV D 1500 P 52W 940 PS WT

Photometric and lighting design files		Document name
	UGR file (UGR table)	LN INV D 1500 P 52W 940 PS WT 1050mA
	LDC typ cone	LN INV D 1500 P 52W 940 PS WT 1050mA
	LDC typ polar	LN INV D 1500 P 52W 940 PS WT 1050mA
CAD/BIM files		Document name
	CAD_STEP_3D	LN INV D 1500 G2
Tender texts		Document name
	Tender documents	LINEAR INDIVILED DIRECT 1500 PS 1500 P 52W 940 PS WT-EN

LOGISTICAL DATA

Product code	Packaging unit (Pieces/Unit)	Dimensions (length x width x height)	Gross weight	Volume
4099854135491	Folding box 1	1,252 mm x 167 mm x 87 mm	4660.00 g	18.19 dm ³
4099854135507	Shipping box 2	1,547 mm x 187 mm x 189 mm	10920.00 g	54.68 dm ³

The mentioned product code describes the smallest quantity unit which can be ordered. One shipping unit can contain one or more single products. When placing an order, for the quantity please enter single or multiples of a shipping unit.

ADDITIONAL CATALOG INFORMATION

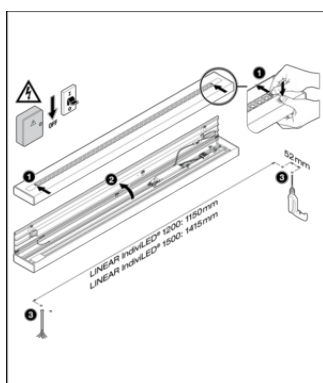

dip switch Preset: ON/ON

LINEAR INDIVILED® DIRECT	DRIVER	dip switch	Pos.1	Pos.2	Presets	RA	W	lm	lm/W
LN INV D 1500 P 40W 930 PS WT	CSMAK	OFF	OFF	OFF	300	25	3000	120	
	SP-F12	ON	ON	ON	400	30	3000	120	
	SP-F12	ON	OFF	ON	300	30	4000	133	
LN INV D 1500 P 40W 940 PS WT	CSMAK	OFF	OFF	OFF	300	25	3000	120	
	SP-F12	ON	ON	ON	400	30	3000	120	
	SP-F12	ON	OFF	ON	300	30	4000	133	
LN INV D 1500 P 52W 930 PS WT	CSMAK	OFF	OFF	OFF	300	40	3000	120	
	SP-F12	ON	ON	ON	400	40	3000	120	
	SP-F12	ON	OFF	ON	300	40	4000	133	
LN INV D 1500 P 52W 940 PS WT	CSMAK	OFF	OFF	OFF	300	40	3000	120	
	SP-F12	ON	ON	ON	400	40	3000	120	
	SP-F12	ON	OFF	ON	300	40	4000	133	

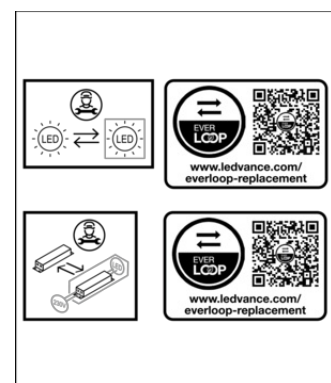

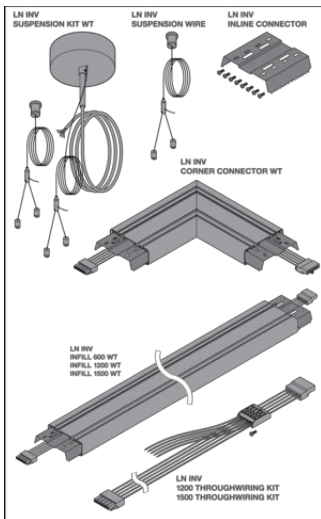

References / Links

– For Guarantee see www.ledvance.com/guarantee

DISCLAIMER

Subject to change without notice. Errors and omission excepted. Always make sure to use the most recent release.