

# PRODUCT DATASHEET

## LN INDV D 1200 34 W 4000 K

LINEAR IndiviLED® DIRECT GEN 1 | Surface mounted luminaire for single luminaire or light line application



### Areas of application

- Direct replacement for luminaires with fluorescent lamps
- Offices, schools
- General indoor illumination
- Corridors, entrance areas
- Seamless linear lighting
- Shop lighting

### Product benefits

- Homogenous light distribution and reduced glare thanks to the IndiviLED® optics
- Multiple mounting options
- The product family offers full lighting solution for different applications
- Energy savings of up to 50 % compared to T5 batten luminaires
- Further variants additionally available with DALI ECG, emergency lighting function according to IEC 60598-2-22 or through wiring
- Robust structure with IK06
- Low flicker light thanks to special electronic control gear
- 5 years guarantee

### Product features

- Each LED with individual lens and reflector for UGR < 16 and homogenous light distribution
- Pendant mounting with suspension kit



- Linkable into seamless light line with line connection adapter (surface or pendant mounting)
- Available with length of 1200 or 1500 mm
- Luminous flux up to 5700 lm
- Luminous efficacy: up to 125 lm/W
- Initial color consistency: 3 SDCM
- Glow Wire Test according to IEC 60695-2-12: 850 °C
- Versions available with CRI 90
- Luminaire versions with IoT-ready DALI-2 driver or IoT Zigbee 3.0 technology available
- Lifetime (L70/B50): 60,000 h (at 25 °C)

## TECHNICAL DATA

### Electrical data

Nominal wattage	34.00 W
Nominal voltage	220...240 V
Mains frequency	50...60 Hz
Nominal current	190 mA
Inrush current	25 A
Inrush current time $T_{h50}$	100 $\mu$ s
Max. number of luminaires per miniature circuit breaker B16	30
Max. number of luminaires per miniature circuit breaker C10	24
Max. number of luminaires per miniature circuit breaker C16	38
Power factor $\lambda$	> 0.90
Total harmonic distortion	$\leq$ 18 %
Protection class	I
Operating mode	Integrated LED driver

### Photometrical data

Luminous flux	4200 lm
Luminous efficacy	120 lm/W
Color temperature	4000 K
Light color (designation)	Cool White
Color rendering index Ra	$\geq$ 80
Standard deviation of color matching	3 sdc <sub>m</sub>
Luminous intensity	-
Low flicker	Yes
Flickering metric (Pst LM)	-
Stroboscope effect metric (SVM)	-
Photobiological safety group acc. to EN62778	RG1
Photobiological safety group acc. to EN62471	RG0
Beam angle	70 °
UGR	< 16

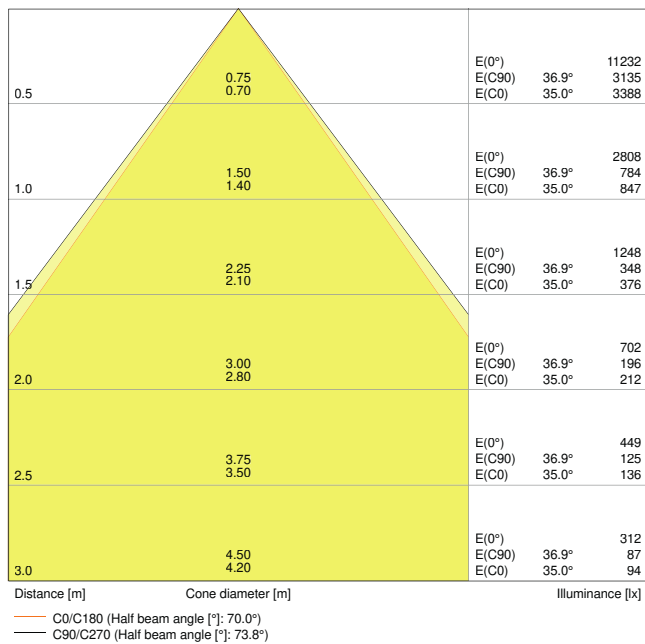

LN INDV D 1200 34W 4000K

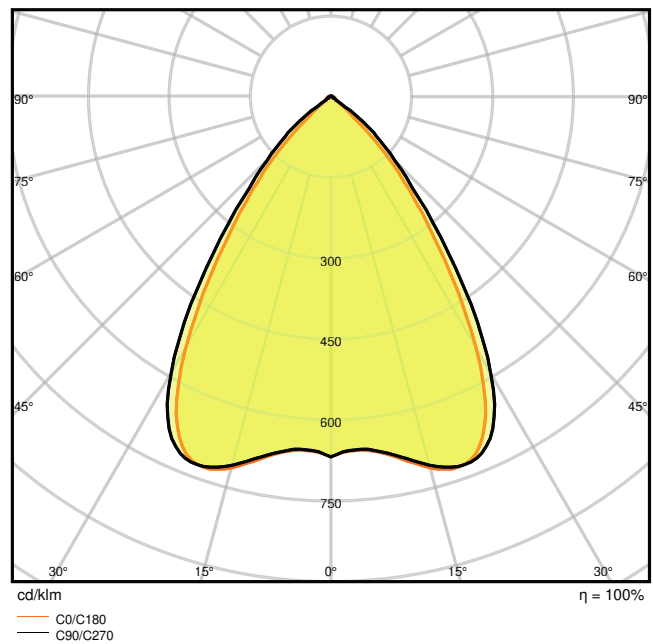

LN INDV D 1200 34W 4000K

Dimensions & Weight

Length	1199.00 mm
Width	120.00 mm
Height	40.00 mm
Product weight	2400.00 g

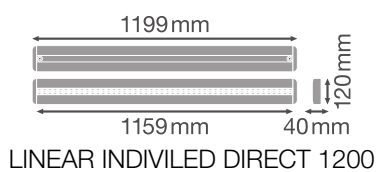

Materials & Colors

Product color	White
Housing color	White
Body material	Aluminum
Cover material	Aluminum

Light emitting surface material	Polycarbonate (PC)
Glow Wire Test according to IEC 60695-2-12	650 °C
Mercury content	0.0 mg

### Application & Mounting

Ambient temperature range	-20...+45 °C
Type of connection	Screwless terminal
Type of protection	IP20
Protection class IK (shock resistance)	IK06
Dimmable	No
Mounting type	Suspended/Surface
Mounting location	Ceiling
Application environment	Indoor
LED module replaceable	Not replaceable
With light source	Yes

### Lifespan

Lifespan L70/B50 at 25 °C	60000 h <sup>1)</sup>
Lifespan L80/B10 at 25 °C	50000 h <sup>1)</sup>
Lifespan L90/B10 at 25 °C	35000 h
Number of switching cycles	100000

<sup>1)</sup> t[h]: L70 / B50 @ 25 °C (Ta), t[h]: L80 / B10 @ 25 °C (Ta), t[h]: L90 / B10 @ 25 °C (Ta)





### Certificates & Standards







Standards	CE / CB / TÜV SÜD / EAC
Luminaire with limited surface temperature, "D sign"	No
Ball shot safe	No

### EQUIPMENT / ACCESSORIES

- Ceiling connection box available
- Suspension kit available
- Line connection adapter available
- Through-wiring cable kit available

### DOWNLOAD DATA

Documents and certificates		Document name
	User Instruction	UI_Linear_IndiviLED
	Addon Technical Information	LSI LINEAR IndiviLED
	On-Pack-Info	Legal Insert Linear
	Declarations of conformity	CE LN IndiviLED

Photometric and lighting design files		Document name
	IES file (IES)	LN INDV D 1200 34W 4000K
	LDT file (Eulumdat)	LN INDV D 1200 34W 4000K
	ULD file (DIALux)	LINEARIndiviLEDDIRECT120034W4000K
	ROLF file (RELUX)	LN INDV D 1200
	UGR file (UGR table)	LN INDV D 1200 34W 4000K
	LDC typ cone	LN INDV D 1200 34W 4000K
	LDC typ polar	LN INDV D 1200 34W 4000K

CAD/BIM files		Document name
	CAD_STEP_3D	LN INDV 1200

Tender texts		Document name
	Tender documents	LINEAR IndiviLED DIRECT 1200 34 W 4000 K-EN

**LOGISTICAL DATA**

Product code	Packaging unit (Pieces/Unit)	Dimensions (length x width x height)	Gross weight	Volume
4058075109629	Folding box 1	132 mm x 1,334 mm x 52 mm	2393.00 g	9.16 dm <sup>3</sup>
4058075109636	Shipping box 4	1,357 mm x 207 mm x 169 mm	11302.00 g	47.47 dm <sup>3</sup>

The mentioned product code describes the smallest quantity unit which can be ordered. One shipping unit can contain one or more single products. When placing an order, for the quantity please enter single or multiples of a shipping unit.

**ADDITIONAL CATALOG INFORMATION**

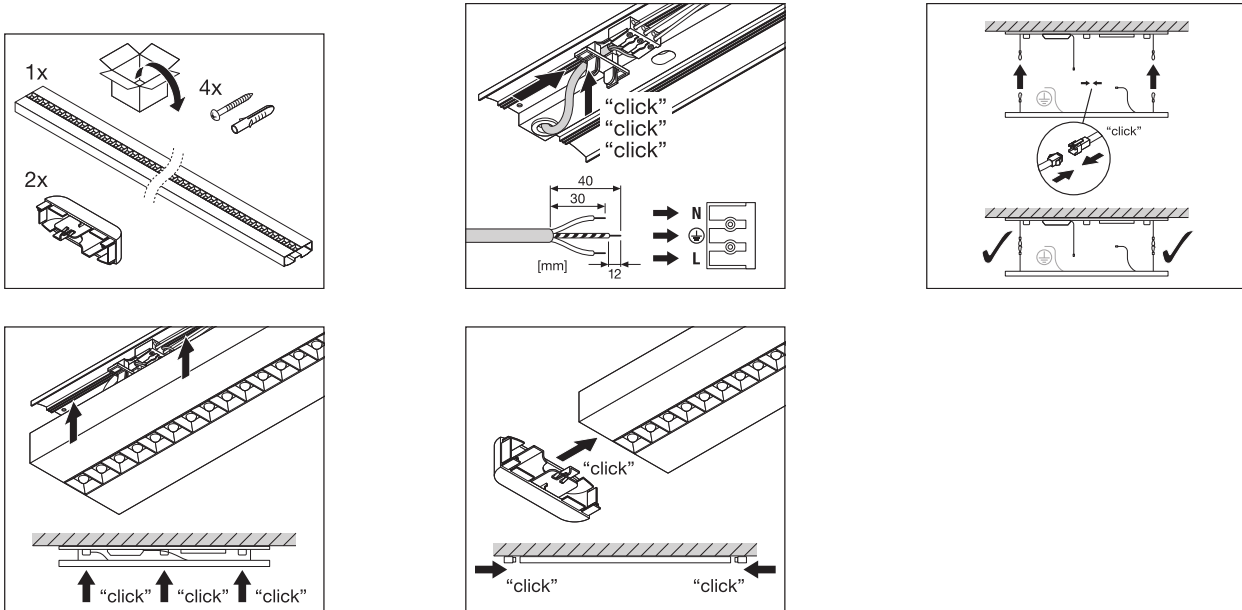

**References / Links**

– For Guarantee see [www.ledvance.com/guarantee](http://www.ledvance.com/guarantee)

**DISCLAIMER**

Subject to change without notice. Errors and omission excepted. Always make sure to use the most recent release.