

PRODUCT DATASHEET

DL ALU DALI DN 150 14 W 4000 K IP44/IP20 WT

DOWNLIGHT ALU DALI | Downlight luminaires with aluminum housing and DALI driver



Areas of application

- Direct replacement for luminaires with compact fluorescent lamps
- General illumination
- Public areas
- Stairways
- Corridors
- Foyers
- Shops

Product benefits

- Advanced functionality due to already included DALI driver
- DALI driver with individual luminaire current set-up already installed
- High luminous efficacy
- Energy savings up to 60 % (compared to luminaires that use CFL lamps)
- Very homogenous light
- Functional design
- Easy installation with fast connection
- 5 years guarantee

Product features



- Advanced applications with DALI light installations
- Diameter of required ceiling cut-out: 150 mm or 200 mm (depending on version)
- Type of protection: IP44

TECHNICAL DATA

Electrical data

Nominal wattage	14.00 W
Nominal voltage	220...240 V
Mains frequency	0/50/60 Hz
Nominal current	100.000 mA
Inrush current	20 A
Inrush current time T_{h50}	140 μ s
Max. number of luminaires per miniature circuit breaker B16	32
Max. number of luminaires per miniature circuit breaker C10	31
Max. number of luminaires per miniature circuit breaker C16	53
Power factor λ	> 0.90
Total harmonic distortion	< 20 %
Protection class	II
Operating mode	External LED driver

Photometrical data

Luminous flux	1260 lm
Luminous efficacy	90 lm/W
Color temperature	4000 K
Light color (designation)	Cool White
Color rendering index Ra	> 80
Standard deviation of color matching	< 6 sdc _m
Luminous intensity	-
Flickering metric (Pst LM)	-
Stroboscope effect metric (SVM)	-
Photobiological safety group acc. to EN62778	RG0
Photobiological safety group acc. to EN62471	RG0
Beam angle	100 °

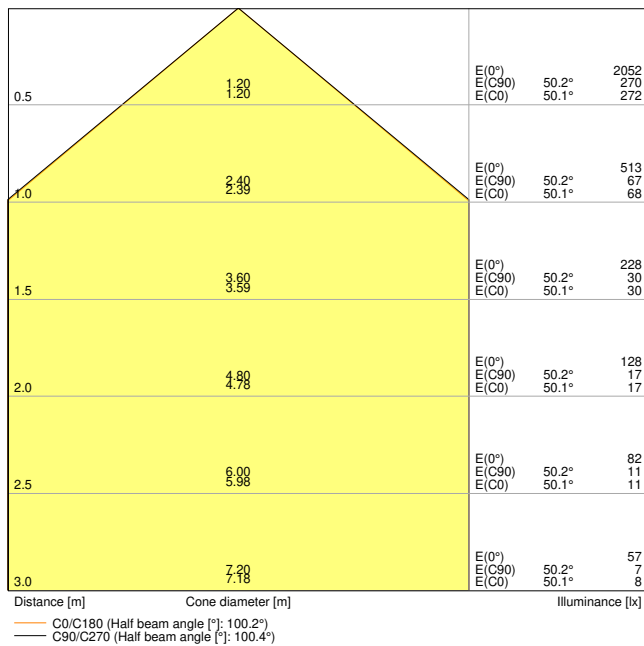

DL ALU DALI DN150 14W 4000K WT IP44

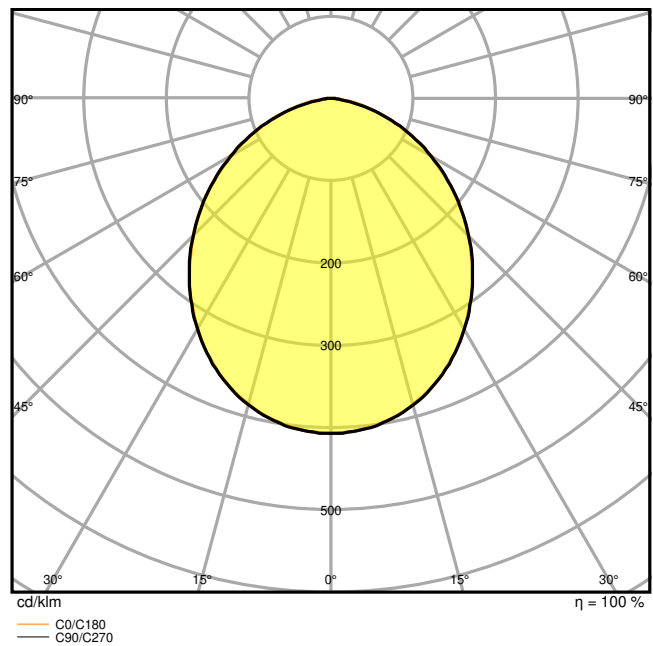

DL ALU DALI DN150 14W 4000K WT IP44

Dimensions & Weight

Diameter	160.00 mm
Height	52.00 mm
Product weight	360.00 g

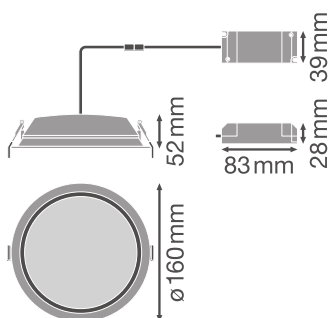

DL ALU DN150 14W

Materials & Colors

Product color	White
Housing color	White

Body material	Aluminum
Cover material	Polymethylmethacrylate (PMMA)
Glow Wire Test according to IEC 60695-2-12	650 °C
Mercury content	0.0 mg

Application & Mounting

Ambient temperature range	-20...+45 °C
Type of connection	Screwless terminal, 5-Pole
Type of protection	IP44/IP20
Protection class IK (shock resistance)	IK02
Dimmable	Yes
Type of dimming	DALI
Mounting type	Recessed
Mounting location	Ceiling
Application environment	Indoor
Mounting diameter	150 mm
Mounting depth	100 mm
LED module replaceable	Not replaceable
With light source	Yes

Lifespan

Lifespan L70/B50 at 25 °C	50000 h ¹⁾
Lifespan L80/B10 at 25 °C	45000 h ¹⁾
Lifespan L90/B10 at 25 °C	30000 h
Number of switching cycles	100000

¹⁾ t[h]: L70 / B50 @ 25 °C (Ta), t[h]: L80 / B10 @ 25 °C (Ta), t[h]: L90 / B10 @ 25 °C (Ta)

Certificates & Standards

Standards	CE / CB / EAC
Luminaire with limited surface temperature, "D sign"	No
Ball shot safe	No





Additional product data







Number of illuminants	Not relevant
-----------------------	--------------



Accessories Optional

Product image	Product name	EAN
	EM CONVERSION BOX	4058075237025

DOWNLOAD DATA

Documents and certificates		Document name
	User Instruction	DOWNLIGHT ALU DALI
	Addon Technical Information	LSI DL ALU DALI
	Declarations of conformity	Declaration of conformity
	Declarations Of Conformity UKCA	DL ALU DALI WT IP44

Photometric and lighting design files		Document name
	IES file (IES)	DL ALU DALI DN150 14W 4000K WT IP44
	LDT file (Eulumdat)	DL ALU DALI DN150 14W 4000K WT IP44
	ULD file (DIALux)	DL ALU DALI DN150 14W-4000K WT
	ROLF file (RELUX)	DL ALU DALI DN150 14W-4000K
	UGR file (UGR table)	DL ALU DALI DN150 14W 4000K WT IP44
	LDC typ cone	DL ALU DALI DN150 14W 4000K WT IP44
	LDC typ polar	DL ALU DALI DN150 14W 4000K WT IP44

CAD/BIM files		Document name
	BIM_Revit_3D	Downlight ALU
	CAD_STEP_3D	DL ALU 14W

Tender texts	Document name
 Tender documents	DOWNLIGHT ALU DALI 150 14 W 4000 K IP44IP20 WT-EN

LOGISTICAL DATA

Product code	Packaging unit (Pieces/Unit)	Dimensions (length x width x height)	Gross weight	Volume
4058075202634	Folding box 1	322 mm x 222 mm x 114 mm	525.00 g	8.15 dm ³
4058075202641	Shipping box 8	658 mm x 466 mm x 263 mm	4955.00 g	80.64 dm ³

The mentioned product code describes the smallest quantity unit which can be ordered. One shipping unit can contain one or more single products. When placing an order, for the quantity please enter single or multiples of a shipping unit.

ADDITIONAL CATALOG INFORMATION

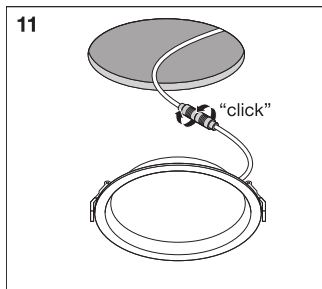

References / Links

– For Guarantee see www.ledvance.com/guarantee

DISCLAIMER

Subject to change without notice. Errors and omission excepted. Always make sure to use the most recent release.