

# PRODUCT DATASHEET

## DL UGR19 PFM DN155 14 W 840 WT IP54 ZBVR

DOWNLIGHT UGR19 ZIGBEE | Low-glare downlights, suitable for computer screen workstations with Zigbee 3.0 technology



### Areas of application

- Suitable for office applications, especially for computer screen workplaces
- Direct replacement for luminaires with compact fluorescent lamps
- Entrances / Hallways
- Bathrooms, kitchens and sheltered outdoor areas
- General illumination

### Product benefits

- Suitable luminaire for VIVARES and other Zigbee 3.0 Light Management Systems
- Good glare reduction (UGR < 19) and cut off angle up to 30° for comfortable indoor lighting
- Easy and quick installation thanks to connector box with 5-pole toolless terminal
- Low flicker light
- Suitable for use in dusty and damp locations thanks to high IP rating
- 5 years guarantee

### Product features

- IoT-ready luminaire with Zigbee 3.0 technology
- Housing material: Aluminum mirror-finished reflector
- Type of protection: IP54 (room side) / IP20 (back side)
- Connector box with push wire terminal for tool-free connection



- Through-wiring possible

## TECHNICAL DATA

### Electrical data

Nominal wattage	14.00 W
Nominal voltage	220...240 V
Mains frequency	50...60 Hz
Nominal current	80 mA
Inrush current	30 A
Inrush current time $T_{h50}$	200 $\mu$ s
Max. number of luminaires per miniature circuit breaker B16	120
Max. number of luminaires per miniature circuit breaker C10	80
Max. number of luminaires per miniature circuit breaker C16	120
Power factor $\lambda$	$\geq 0.90$
Total harmonic distortion	< 20 %
Protection class	II
Operating mode	External LED driver

### Photometrical data

Luminous flux	1600 lm
Luminous efficacy	115 lm/W
Color temperature	4000 K
Light color (designation)	Cool White
Color rendering index Ra	$\geq 80$
Standard deviation of color matching	$\leq 5$ sdc <sub>m</sub>
Luminous intensity	-
Low flicker	Yes
Flickering metric (Pst LM)	-
Stroboscope effect metric (SVM)	-
Photobiological safety group acc. to EN62778	RG1
Photobiological safety group acc. to EN62471	RG0
Beam angle	65 °
UGR	< 19

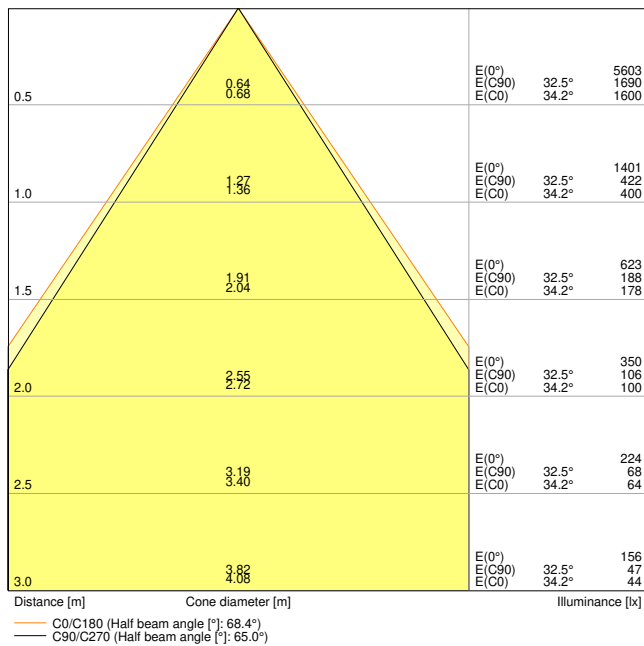

DL\_UGR19\_DN155\_PFM\_14W840\_ZBVR\_WT

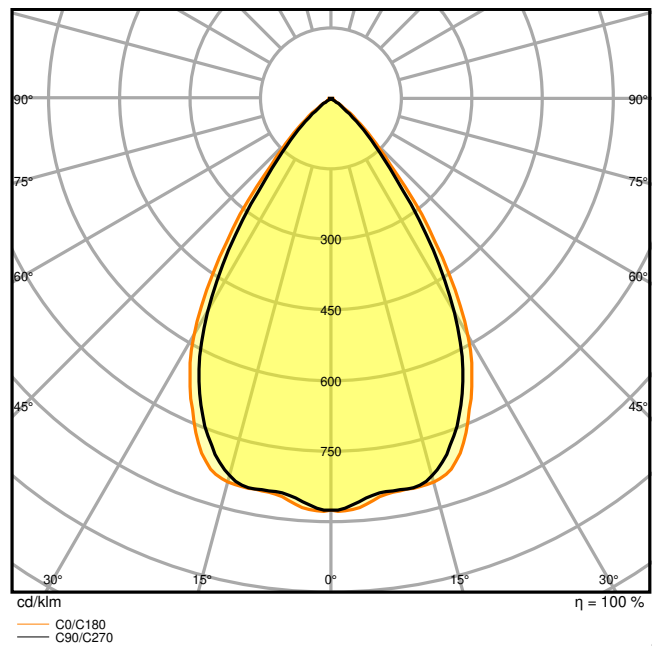

DL\_UGR19\_DN155\_PFM\_14W840\_ZBVR\_WT

Dimensions & Weight

Diameter	180.00 mm
Height	65.00 mm
Product weight	650.00 g

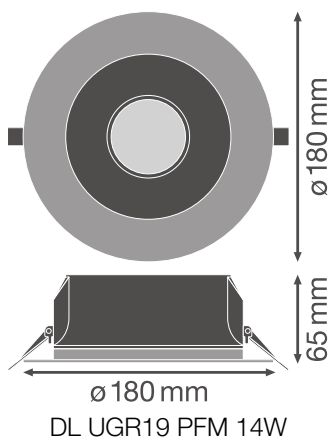

Materials & Colors

Product color	White
Housing color	White
Body material	Aluminum
Cover material	Polycarbonate (PC)
Light emitting surface material	Polycarbonate (PC)
Glow Wire Test according to IEC 60695-2-12	650 °C
Mercury content	0.0 mg

### Application & Mounting

Ambient temperature range	-20...+45 °C
Temperature range at storage	-40...+70 °C
Type of connection	Screwless terminal, 5-Pole (L, N, PE, DA+, DA-)
Type of protection	IP54/IP20
Protection class IK (shock resistance)	IK03
Dimmable	Yes
Type of dimming	ZIGBEE
Mounting type	Recessed
Mounting location	Ceiling
Application environment	Indoor
Mounting diameter	155,0 mm
Mounting depth	100 mm
LED module replaceable	Not replaceable
With light source	Yes

### Lifespan

Lifespan L70/B50 at 25 °C	70000 h <sup>1)</sup>
Lifespan L80/B10 at 25 °C	60000 h <sup>1)</sup>
Lifespan L90/B10 at 25 °C	40000 h
Number of switching cycles	100000

<sup>1)</sup> t[h]: L70 / B50 @ 25 °C (Ta), t[h]: L80 / B10 @ 25 °C (Ta), t[h]: L90 / B10 @ 25 °C (Ta)

### Control gear

Output current	450 mA
ECG - Output ripple current	≤ 10 %
ECG - Length	180 mm
ECG - Width	44 mm

ECG - Height	33 mm
--------------	-------

Certificates & Standards

Standards	CE / CB / ENEC / TÜV SÜD / EAC
Luminaire with limited surface temperature, "D sign"	No
Ball shot safe	No







Additional product data





Number of illuminants	Not relevant
-----------------------	--------------





EQUIPMENT / ACCESSORIES



– External control gear included

DOWNLOAD DATA

Documents and certificates		Document name
	User Instruction	DL UGR19 PFM
	Addon Technical Information	LSI DL UGR19 PFM
	Extended installation guide	Quick Installation Guide Vlvares Zigbee
	Legal information	Legal insert DL UGR19 PFM
	Declarations of conformity	EU Declaration of Conformity
	Declarations Of Conformity UKCA	DL UGR19 PFM WT

Photometric and lighting design files		Document name
	IES file (IES)	DL UGR19 DN155 PFM 14W 840 ZBVR WT
	LDT file (Eulumdat)	DL UGR19 DN155 PFM 14W 840 ZBVR WT
	ULD file (DIALux)	DL UGR19 DN155 PFM 14W-840 ZBVR WT
	ROLF file (RELUX)	DL UGR19 DN155 PFM 14W-840

Photometric and lighting design files		Document name
	UGR file (UGR table)	DL UGR19 DN155 PFM 14W840 ZBVR WT
	UGR file (UGR table)	DL UGR19 DN155 PFM 14W 840 ZBVR WT
	UGR file (UGR table)	DL_UGR19_DN155_PFM_14W840_ZBVR_WT
	LDC typ cone	DL_UGR19_DN155_PFM_14W840_ZBVR_WT
	LDC typ polar	DL_UGR19_DN155_PFM_14W840_ZBVR_WT

CAD/BIM files		Document name
	BIM_Revit_3D	DL UGR19
	CAD_STEP_3D	DL UGR19 14W

Tender texts		Document name
	Tender documents	DOWNLIGHT UGR19 ZIGBEE DN155 14 W 840 WT IP54 ZBVR-EN

LOGISTICAL DATA

Product code	Packaging unit (Pieces/Unit)	Dimensions (length x width x height)	Gross weight	Volume
4058075459892	Folding box 1	215 mm x 84 mm x 219 mm	850.00 g	3.96 dm <sup>3</sup>
4058075459908	Shipping box 24	526 mm x 449 mm x 468 mm	21806.00 g	110.53 dm <sup>3</sup>

The mentioned product code describes the smallest quantity unit which can be ordered. One shipping unit can contain one or more single products. When placing an order, for the quantity please enter single or multiples of a shipping unit.

ADDITIONAL CATALOG INFORMATION

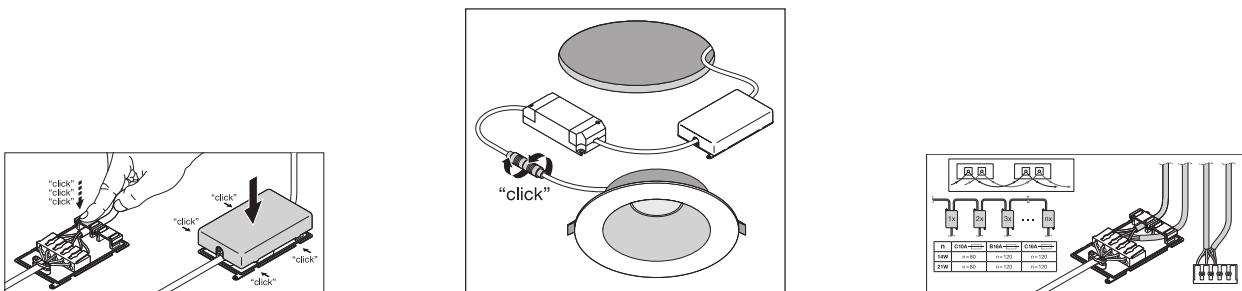

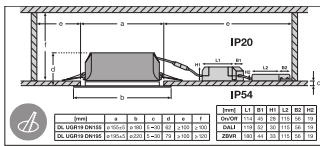

## References / Links

– For Guarantee see [www.ledvance.com/guarantee](http://www.ledvance.com/guarantee)

## DISCLAIMER

Subject to change without notice. Errors and omission excepted. Always make sure to use the most recent release.