

# PRODUCTINFORMATIEBLAD

## PL COMP 600 V 33W 830 U19

PANEL COMPACT 600 UGR<19 | Vierkante panel inbouwarmaturen met lage verblinding, voor plafondsysteem van 600 x 600 mm

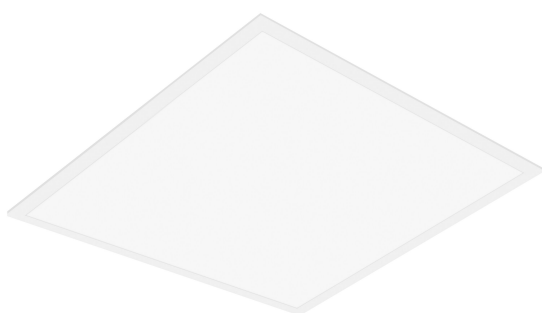

### Toepassingsgebieden

- Directe vervanging voor armaturen met fluorescentielampen
- Kantoren, vergaderruimtes
- Receptie, foyers, gangen, liften
- Geschikt voor inbouwplafondsysteem met rastergrootte van 600 x 600 mm

### Productvoordelen

- Goede verblindingsvermindering (UGR < 19)
- Armatuur met weinig flikkering dankzij speciaal elektronisch voorschakelapparaat
- Energiebesparing dankzij systeemefficiëntie tot 110 lm/W
- Externe driver met optionele 3-polige doorvoerbedrading
- Versies met DALI E-VSA beschikbaar
- 5 jaar garantie

### Productkenmerken

- Frame van geëxtrudeerd aluminium
- Polystyrene diffuser
- Levensduur (L80/B10): tot 50.000 uur (bij 25°C)



## TECHNISCHE GEGEVENS

## ELEKTRISCHE GEGEVENS

Nominale vermogen	33,00 W
Nominale spanning	220...240 V
Netfrequentie	50...60 Hz
Nominale stroom	150,000 mA
Inschakelstroom	12,3 A
Inschakelstroomtijd $T_{h50}$	52 $\mu$ s
Max. armaturen op stroomonderbreke B16 A	61
Max. aantal armaturen per leidingbeveiligingsschakelaar C10	48
Max. aantal armaturen per leidingbeveiligingsschakelaar C16	78
Arbeidsfactor $\lambda$	> 0,90
Totale harmonische vervorming	< 10 %
Veiligheidsklasse	II
Bedrijfsmodus	External LED driver

## Fotometrische gegevens

Lichtstroom	3630 lm
Lichtstroom efficiëntie	110 lm/W
Kleurtemperatuur	3000 K
Lichtkleur	Warm White
Kleurweergave-index Ra	> 80
Standaardafwijking van kleurproeven	$\leq$ 5 sdc <sub>m</sub>
Flikkervrij	Ja
Flikkerwaarde Pst LM	<1
Stroboscoopeffect waarde SVM	< 0.4
Fotobiologische veiligheidsgroep EN62778	RG0
Stralingshoek	90 °
UGR longitudinal	< 19

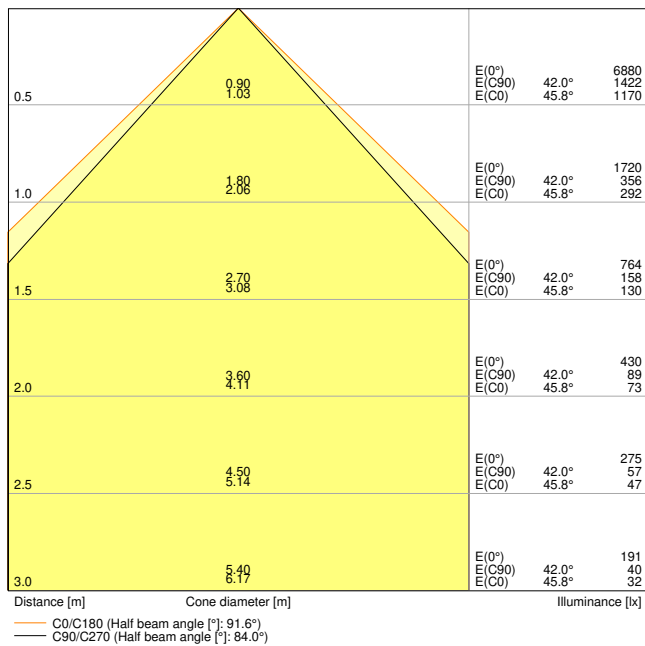

PL COMP 600 V 33W 830 U19 EM CONVERSION BOX

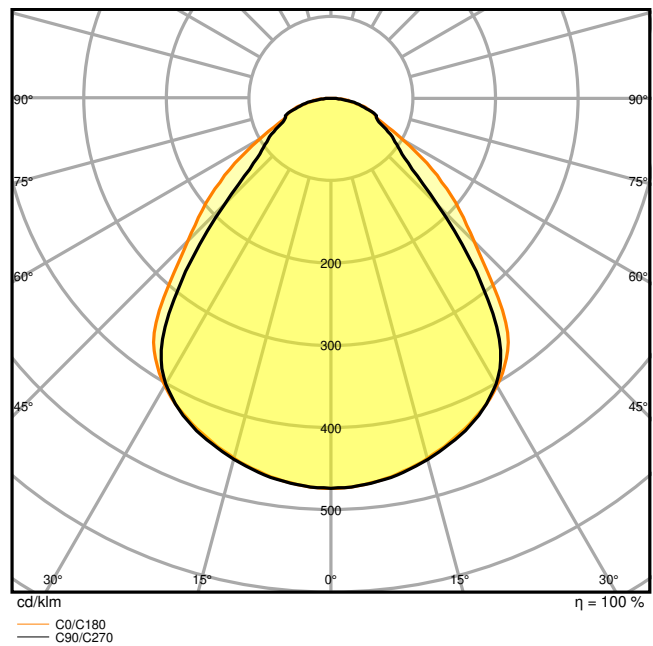

PL COMP 600 V 33W 830 U19 EM CONVERSION BOX

AFMETINGEN & GEWICHT

Lengte	595,00 mm
Breedte	595,00 mm
Hoogte	32,00 mm
Product gewicht	1790,00 g

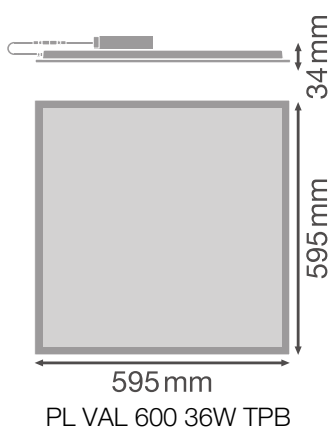

MATERIALEN & KLEUREN

Kleur van het product	Wit
Kleur behuizing	Wit
Body materiaal	Aluminium
Materiaal afdekking	Polystyreen (PS)
Materiaal van lichtuitstralend oppervlak	Polystyreen
Glow Wire Test volgens IEC 60695-2-12	650 °C
Kwikgehalte	0.0 mg

## TOEPASSING & MONTAGE

Omgevingstemperatuur bereik	-10...+45 °C
Opslagtemperatuur	-20...+70 °C
Type aansluiting	Schroefloze terminal, 2-polig (L, N)
Type bescherming	IP40/IP20
Beschermklasse IK ( Schok bestendi [PIM])	IK02
Dimbaar	Nee
Montagetype	Inbouw/pendel/opbouw
Montagelocatie	Plafond
Toepassingsomgeving	Indoor
Inbouwlengte	575 mm
Inbouwbreedte	575 mm
Inbouwdiepte	50,0 mm
Instelbaar	Nee
Vervangbare LED module	Niet vervangbaar
Met lichtbron	Ja

## Levensduur

Levensduur L70/B50 @ 25 °C	70000 h <sup>1)</sup>
Levensduur L80/B10 @ 25 °C	50000 h <sup>1)</sup>
Levensduur L90/B10 @ 25 °C	40000 h
Aantal schakelcycli	50000

<sup>1)</sup> t[h]: L70 / B50 @ 25 °C (Ta), t[h]: L80 / B10 @ 25 °C (Ta), t[h]: L90 / B10 @ 25 °C (Ta)

## VOORSCHAKELAPPARATUUR







Uitgangsstroom:	700 mA
E-VSA - Uitgangsrimpelstroom	< 7 %
E-VSA - Lengte	116.7 mm



E-VSA - Breedte	49.9 mm
ECG - Hoogte	27 mm
Aanbevolen voorschakelapparatuur	LEDV DR DALI-P-44/220-240/1050

### CERTIFICATEN & NORMEN

Normen	CE / CB / TUV / UKCA / EAC / EPD
Gelimiteerde oppervlaktetemperatuur	Nee
Balschot veilig	Nee
EPD	LEDV-00008-V01.01-EN

### OPTIONELE ACCESSOIRES









Product afbeelding	Naam product	EAN
	DR DALI - P -44/220-240/1050	4058075779723
	DR AY ZB+DALI CLAMP DUO	4058075483125
	EM CONVERSION BOX	4058075237025
	PANEL 600 SURFACE MOUNT KIT H75	4058075472914
	PANEL 600 SURFACE MOUNT KIT H70 VAL	4058075402843
	PANEL RECESSED MOUNT CLIPS VAL 4x	4058075409859
	PANEL 600 RECESSED MOUNT FRAME	4058075402881





Product afbeelding	Naam product	EAN
	PANEL Suspension Kit	4058075402928
	CONNECTOR BOX 5POLE L/N 4x	4058075473010



### Technische uitrusting

- Accessoires voor meerdere montage opties beschikbaar
- Beveiligingskoord voor armatuur inbegrepen
- Beveiligingsbeugels voorgeïnstalleerd
- Extern voorschakelapparaat inbegrepen
- Geschikt voor gebruik met losse Emergency Conversion Box

### DOWNLOADS

Documenten en certificaten	Naam document
 User Instruction	UI PANEL COMPACT 2CCT
 Legal information	LISO Insert PL COMP 600 V
 Legal information	EM Insert PL COMP
 Legal information	Informationstext 18 Abs 4 ElektroG
 Declarations of conformity	CE Declaration of Conformity PL COMP V
 Declarations Of Conformity UKCA	UKCA Declaration of Conformity PL COMP V
Fotometrische- en lichtontwerpbestanden	Naam document
 IES file (IES)	PL COMP 600 V 33W 830 U19 EM CONVERSION BOX
 LDT file (Eulumdat)	PL COMP 600 V 33W 830 U19 EM CONVERSION BOX

Fotometrische- en lichtontwerpbestanden		Naam document
	ULD file (DIALux)	PL COMP 600 V 33W 830
	ROLF file (RELUX)	PL COMP 600 V 33W 830 U19
	UGR file (UGR table)	PL COMP 600 V 33W 830 U19
	LDC typ cone	PL COMP 600 V 33W 830 U19 EM CONVERSION BOX
	LDC typ polar	PL COMP 600 V 33W 830 U19 EM CONVERSION BOX

CAD/BIM-bestanden		Naam document
	BIM_Revit_3D	Panel Compact
	CAD_STEP_3D	PL COMP 600

Aanbestedingsteksten		Naam document
	Tender documenten	PANEL COMPACT 600 UGR 19 33W 830 U19-NL

## LOGISTIEKE GEGEVENS

Productcode	Verpakkingseenheid (stuks per verpakking)	Afmetingen (lengte x breedte x hoogte)	Brutogewicht	Volume
4099854017063	Vouwdoos 1	602 mm x 37 mm x 662 mm	2220.00 g	14.75 dm <sup>3</sup>
4099854017070	Verzenddoos 4	677 mm x 164 mm x 628 mm	9790.00 g	69.73 dm <sup>3</sup>

De genoemde productcodes beschrijven de kleinste hoeveelheid die besteld kan worden. Eén verzendeenheid kan bestaan uit één of meer afzonderlijke producten. Bij het plaatsen van een order enkele of veelvoud van de verpakkingseenheid invoeren.

## AANVULLENDE CATALOGUSINFORMATIE

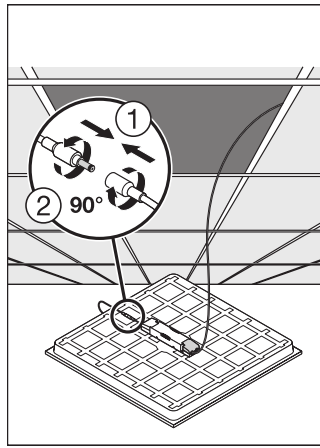
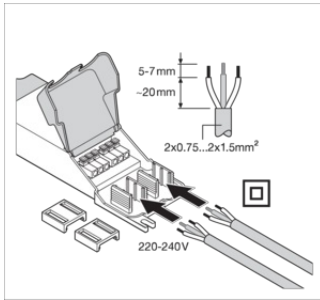

---

### Referenties / Links

– Voor garantie zie [www.benelux.ledvance.com/garantie](http://www.benelux.ledvance.com/garantie)

---

### DISCLAIMER

Onder voorbehoud van verandering zonder kennisgeving. Fouten en drukfouten voorbehouden. Zorg ervoor dat u de meest recente versie gebruikt.