

**10" PDUs**  
**19" PDUs**  
**Zero-U PDUs**

**Cat. Nos: 6 468 00/01/05/06/07/09/10/11/12/13/14/15/18/  
 19/20/21/22/23/24/30/31/32/33/35/36/50/51/52/53/54/  
 56/57/59/60/61/70/90/92/94/95/97/98/99,  
 6 469 00/01/02/03/95/96/97/98/99**



CONTENTS	Page
1. GENERAL CHARACTERISTICS .....	1
2. EQUIPMENT AND PERFORMANCE .....	3
3. FUNCTIONS.....	8
4. DIMENSIONS .....	11
5. INSTALLATION .....	11

**1. GENERAL CHARACTERISTICS**

**1.1 Presentation**

Legrand PDUs are designed for supplying power to equipment in 19" enclosures.

They comprise:

- an aluminium casing
- socket modules
- additional functions
- a termination solution
- a mounting solution

Single-phase 230V – 50/60 Hz or three-phase 380 V – 50/60 Hz power supply

The range features three main product families:

- PDUs designed for horizontal installation (10" and 19" PDUs)
- PDUs designed for vertical installation (Zero-U PDUs)
- Accessories

PDUs designed for horizontal installation (10" and 19" PDUs)

10" PDUs to be installed on 10" mounting uprights and 19" PDUs to be installed on 19" mounting uprights. 1U height casing for compactness. Integrated cable guide. Screwless snap-on fixing. End pieces with 180° reversible metal brackets for vertical mounting capability.

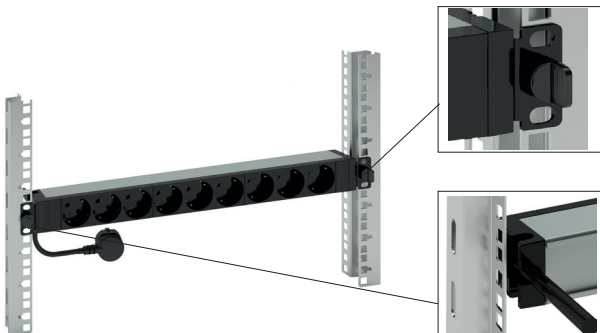

PDUs designed for vertical installation (Zero-U PDUs)

For vertical installation on the rear of cabinets to save 19" space within it.

Cable inlet can be rotated 330° to ensure perfect alignment of the power cable.

Supplied with 2 sets of metal fixings: button for screwless fixing, or standard screw-type brackets.

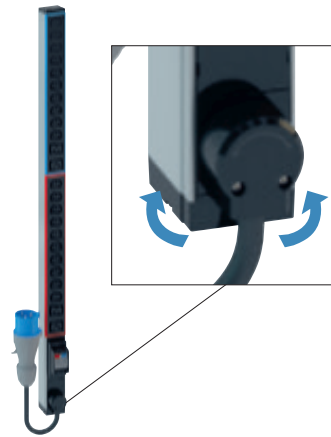

Accessories

- Replacement surge protection module to ensure continuity of service
  - Locking caps for locking out the use of an outlet
- See the detailed description of these accessories in the "Functions" section.

Legrand's PDU offer is available as standard catalogue versions (see the corresponding descriptions in the "Equipment and performance" section) and as customized configurations.

**1.2 Mechanical characteristics**

- Casing: 6060 T5-R19 natural anodised aluminium

Dimensions in mm:

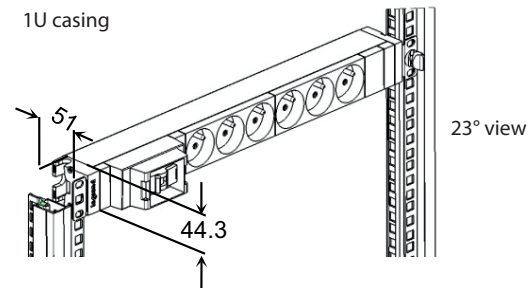

1U casing

View from above

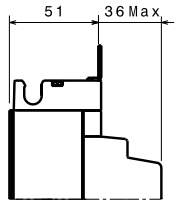

End view

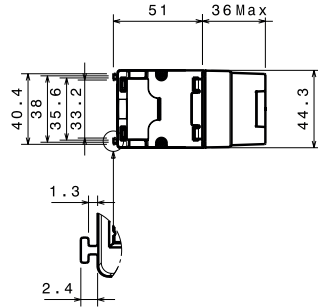

Zero-U casing

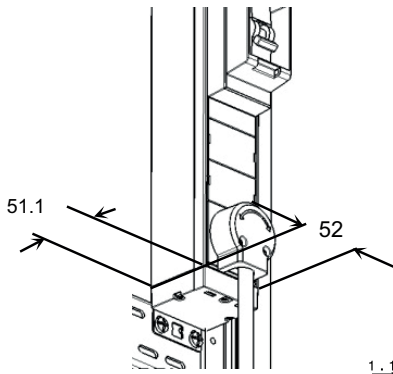

Side view

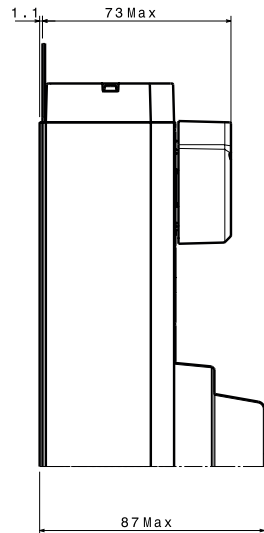

End view

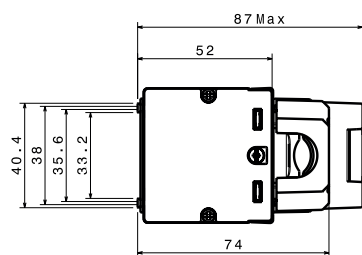

- Outlet modules:

PC/ABS  
CW507L (CuZn 36) brass

- Fixing brackets:

DC01-A-m galvanised steel

■ 1.3 Environmental features

Transport and storage temperature: -20 to + 70 °C

Operating temperature: +5 to + 45 °C

■ 1.4 Standards, regulations and tests

Depending on what equipment they comprise, the PDUs comply with the current applicable standards below:

Application	Standard
French/Belgian standard plugs/outlets	IEC/TR 60083
German standard plugs/outlets	
UK standard plugs/outlets + electrical accessories	
Italian standard outlets	
Swiss standard outlets	
C13 and C19 connectors for electrical equipment	IEC 60320-2-2
Low voltage surge protection device	IEC 61643-11
Switch	IEC 61058-1
MCB	IEC 60898-1
RCBO	IEC 61008-1
Thermal circuit breaker	EN 60934
Industrial plug	IEC 60309-1
Information-processing equipment	IEC 60950-1

IP: IP40 for French/Belgian, German, Swiss, Italian and UK standards and IP20 for electrical appliance connectors (C13 and C19)

IK07

Glow-wire flammability test: The various different standard outlets and the other functions that equip the PDUs meet the requirements of their respective standards relating to abnormal heat and fire resistance and comply with the following thresholds:

- Plastic parts in contact with live parts: 750 °C
- Other plastic parts: 650 °C

Temperature rise: The PDUs are compliant with the standard temperature rise limit of 45 °C for French/Belgian, German, Swiss and Italian standards and electrical appliance connectors (C13 and C19) and 52 °C for the UK standard.

Final inspection: Compliant with European standard requirements and Legrand's own manufacturing requirements, all products undergo production tests, including:

- Electrical continuity to ensure the product is wired correctly
- Dielectric strength at 2000 V to ensure there is no leakage current
- Operating test

RoHS and REACH conformity: The PDUs comply with European standards and therefore meet the requirements of the RoHS directive (Restriction of Hazardous Substances) and REACH regulations (Registration, Evaluation, Authorisation & restriction of Chemicals).

## 2. EQUIPMENT AND PERFORMANCE

### ■ 2.1 Composition of each catalogue number

#### 10" PDUs

	6 468 98	6 468 00	6 468 01
Number of phases	1	1	1
Input voltage	230 V	230 V	230 V
Input current	16 A	16 A	16 A
Maximum power	3.7kW	3.7kW	3.7kW
Termination method		Cord	Cord
Cable length		1 m	1 m
Cable material		PVC HOSVVF	PVC HOSVVF
Cable cross-section		3G 1.5	3G 1.5
Plug type		Schuko/UTE	Schuko/UTE
Cable retention method		Cable clamp + guide	Cable clamp + guide
Number and type of outlets		4 French/Belgian	4 German
Outlets colour		Black	Black
Angle of outlets		55°	55°
Number of circuits per phase		1	1
Casing	Zero-U aluminium	1U aluminium	1U aluminium
Fixings (included)	19" reversible bracket + snap-on fixing	19" reversible bracket + snap-on fixing	19" reversible bracket + snap-on fixing

#### 19" PDUs

	6 468 05	6 468 06	6 468 07	6 468 09	6 468 10	6 468 11	6 468 12	6 468 13	6 468 14
Number of phases	1	1	1	1	1	1	1	1	1
Input voltage	230 V	230 V	230 V	230 V	230 V	230 V	230 V	230 V	230 V
Input current	16 A	16 A	16 A	16 A	16 A	16 A	16 A	13 A	16 A
Maximum power	3.7kW	3.7kW	3.7kW	3.7kW	3.7kW	3.7kW	3.7kW	3kW	3.7kW
Termination method	Cord	Cord	Terminal block**	Terminal block**	Cord	Cord	Cord	Cord	Terminal block**
Cable length	3 m	3 m			3 m	3 m	3 m	3 m	
Cable material	PVC HOSVVF	PVC HOSVVF			PVC HOSVVF	PVC HOSVVF	PVC HOSVVF	PVC HOSVVF	
Cable cross-section	3G 1.5	3G 1.5			3G 1.5	3G 1.5	3G 1.5	3G 1.5	
Plug type	Schuko/UTE	Schuko/UTE			Schuko/UTE	Schuko/UTE	Schuko/UTE	BS 1363	
Cable retention method	Cable clamp + guide	Cable clamp + guide	Cable clamp + guide	Cable clamp + guide	Cable clamp + guide	Cable clamp + guide	Cable clamp + guide	Cable clamp + guide	Cable clamp + guide
Number and type of outlets*	6 French/Belgian	6 German	6 C19 with locking	6 C13 + 2 C19 with locking	9 French/Belgian	9 French/Belgian tamper-proof	9 German	8 UK	10 C13 with locking
Outlet colour	Black	Black	Black	Black	Black	Red	Black	Black	Black
Angle of outlets	55°	55°	90°	90°	55°	55°	55°		90°
Number of circuits per phase	1	1	1	1	1	1	1	1	1
Additional functions									
Casing	1U aluminium	1U aluminium	1U aluminium	1U aluminium	1U aluminium	1U aluminium	1U aluminium	1U aluminium	1U aluminium
Fixings (included)	19" reversible bracket + snap-on fixing								

\* Outlets are equally distributed on each circuit

\*\* Maximum capacity of terminal block 6 mm<sup>2</sup>

**10" PDUs**  
**19" PDUs**  
**Zero-U PDUs**

Cat. Nos: 6 468 00/01/05/06/07/09/10/11/12/13/14/15/18/19/2  
0/21/22/23/24/30/31/32/33/35/36/50/51/52/53/54/  
56/57/59/60/61/70/90/92/94/95/97/98/99,  
6 469 00/01/02/03/95/96/97/98/999

19" PDUs (continued)

	6 468 15	6 468 18	6 468 19	6 468 20	6 468 21	6 468 22	6 468 23	6 468 24	6 468 30
Number of phases	1	1	1	1	1	1	1	1	1
Input voltage	230 V	230 V	230 V	230 V	230 V	230 V	230 V	230 V	230 V
Input current	16 A	16 A	16 A	16 A	16 A	16 A	16 A	13 A	16 A
Maximum power	3.7kW	3.7kW	3.7kW	3.7kW	3.7kW	3.7kW	3.7kW	3kW	3.7kW
Termination method	Cord	Cord	Cord	Cord	Cord	Cord	Cord	Cord	Cord
Cable length	3 m	3 m	3 m	3 m	3 m	3 m	3 m	3 m	3 m
Cable material	PVC HO5VVF	PVC HO5VVF	PVC HO5VVF	PVC HO5VVF	PVC HO5VVF	PVC HO5VVF	PVC HO5VVF	PVC HO5VVF	PVC HO5VVF
Cable cross-section	3G 1.5	3G 1.5	3G 1.5	3G 1.5	3G 1.5	3G 1.5	3G 1.5	3G 1.5	3G 1.5
Plug type	IEC 60309 16 A 2P+E	T23 SEV 1011	T23 SEV 1011	Schuko/ UTE	Schuko/ UTE	Schuko/ UTE	Schuko/ UTE	BS 1363	Schuko/ UTE
Cable retention method	Cable clamp + guide	Cable clamp + guide	Cable clamp + guide	Cable clamp + guide	Cable clamp + guide	Cable clamp + guide	Cable clamp + guide	Cable clamp + guide	Cable clamp + guide
Number and type of outlets*	12 C13 with locking	12 T13 Swiss standard	12 T23 Swiss standard	9 French/ Belgian	9 German	8 French/ Belgian	8 German	6 UK	6 French/ Belgian
Outlet colour	Black	Black	Black	Black	Black	Black	Black	Black	Black
Angle of outlets	90°	90°	90°	55°	55°	55°	55°		55°
Number of circuits per phase	1	1	1	1	1	1	1	1	1
Additional functions				Power indicator	Power indicator	Luminous switch	Luminous switch	Luminous switch	1P MCB C16 6 kA Cat.No. 4 136 06
Casing	1U aluminium	1U aluminium	1U aluminium	1U aluminium	1U aluminium	1U aluminium	1U aluminium	1U aluminium	1U aluminium
Fixings (included)	19" reversible bracket + snap-on fixing								

\* Outlets are equally distributed on each circuit

19" PDUs (continued)

	6 468 31	6 468 32	6 468 33	6 468 35	6 468 36	6 468 99	6 469 03
Number of phases	1	1	1	1	1	1	1
Input voltage	230 V	230 V	230 V	230 V	230 V	230 V	230 V
Input current	16 A	16 A	16 A	16 A	16 A	16 A	16 A
Maximum power	3.7kW	3.7kW	3.7kW	3.7kW	3.7kW	3.7kW	3.7kW
Termination method	Cord	Cord	Cord	Cord	Cord		Cord
Cable length	3 m	3 m	3 m	3 m	3 m		3 m
Cable material	PVC HO5VVF	PVC HO5VVF	PVC HO5VVF	PVC HO5VVF	PVC HO5VVF		PVC HO5VVF
Cable cross-section	3G 1.5	3G 1.5	3G 1.5	3G 1.5	3G 1.5		3G 1.5
Plug type	Schuko/UTE	Schuko/UTE	Schuko/UTE	Schuko/UTE	Schuko/UTE		Schuko/UTE
Cable retention method	Cable clamp + guide	Cable clamp + guide	Cable clamp + guide	Cable clamp + guide	Cable clamp + guide		Cable clamp + guide
Number and type of outlets*	6 German	9 German	6 French/ Belgian	6 French/ Belgian	6 German		7 German
Outlet colour	Black	Black	Black	Black	Black		Black
Angle of outlets	55°	55°	55°	55°	55°		55°
Number of circuits per phase	1	1	1	1	1		1
Additional functions	1P MCB C16 6 kA Cat.No. 4 136 06	1P MCB C16 6 kA Cat.No. 4 136 06	1P RCBO C16 6 kA 30 mA AC type C curve Cat.No. 4 107 05	Surge protection module Luminous switch	Surge protection module Luminous switch		Surge protection module
Casing	1U aluminium	2x1U aluminium	1U aluminium	1U aluminium	1U aluminium	Zero-U aluminium	1U aluminium
Fixings (included)	19" reversible bracket + snap-on fixing						

\* Outlets are equally distributed on each vertical PDU circuit

19" PDUs (continued)

	<b>6 469 95</b>	<b>6 469 96</b>	<b>6 469 97</b>	<b>6 469 98</b>	<b>6 469 99</b>
Number of phases	1	1	1	1	1
Input voltage	230 V	230 V	230 V	230 V	230 V
Input current	16 A	16 A	16 A	16 A	16 A
Maximum power	3.7kW	3.7kW	3.7kW	3.7kW	3.7kW
Termination method	Cord	Cord	Cord	Cord	Cord
Cable length	3 m	3 m	3 m	3 m	3 m
Cable material	PVC H05VVF	PVC H05VVF	PVC H05VVF	PVC H05VVF	PVC H05VVF
Cable cross-section	3G 1.5	3G 1.5	3G 1.5	3G 1.5	3G 1.5
Plug type	Schuko/UTE	Schuko/UTE	Schuko/UTE	Schuko/UTE	Schuko/UTE
Cable retention method	Cable clamp + guide	Cable clamp + guide	Cable clamp + guide	Cable clamp + guide	Cable clamp + guide
Number and type of outlets*	6 P40 (Italian/German)	6 P40 (Italian/German)	6 P40 (Italian/German)	8 P40 (Italian/German)	9 P40 (Italian/German)
Outlet colour	Black	Black	Black	Black	Black
Angle of outlets	90°	90°	90°	90°	90°
Number of circuits per phase	1	1	1	1	1
Additional functions		Luminous switch + surge	1P MCB C16 6 kA Cat.No. 4 136 06	Luminous switch	
Casing	1U aluminium	1U aluminium	1U aluminium	1U aluminium	1U aluminium
Fixings (included)	19" reversible bracket + snap-on fixing				

\* Outlets are equally distributed on each circuit

Zero-U PDUs

	<b>6 468 50</b>	<b>6 468 51</b>	<b>6 468 52</b>	<b>6 468 53</b>	<b>6 468 54</b>	<b>6 468 56</b>
Number of phases	1	1	1	1	1	1
Input voltage	230 V	230 V	230 V	230 V	230 V	230 V
Input current	32 A	32 A	32 A	32 A	32 A	32 A
Maximum power	7.4kW	7.4kW	7.4kW	7.4kW	7.4kW	7.4kW
Termination method	Terminal block**	Cord	Terminal block**	Cord	Terminal block**	Terminal block**
Cable length		3 m		3 m		
Cable material		Rubber HO7RNF		Rubber HO7RNF		
Cable cross-section		3G 4		3G 4		
Plug type		IEC 60309 32 A 2P+E		IEC 60309 32 A 2P+E		
Cable retention method	Cable clamp + rotative system	Cable clamp + rotative system	Cable clamp + rotative system	Cable clamp + rotative system	Cable clamp + rotative system	Cable clamp + rotative system
Number and type of outlets*	24 French/Belgian	24 French/Belgian	24 German	24 German	24 UK	24 C13 with locking
Outlet colour	Black	Black	Black	Black	Black	Black
Angle of outlets	55°	55°	55°	55°	55°	90°
Number of circuits per phase	2	2	2	2	2	2
Identification of circuits (colour-code)	Blue/Red	Blue/Red	Blue/Red	Blue/Red	Blue/Red	Blue/Red
Additional functions	1P+N MCB C16 10 kA Cat.No. 4 077 00	1P+N MCB C16 10 kA Cat.No. 4 077 00	1P+N MCB C16 10 kA Cat.No. 4 077 00	1P+N MCB C16 10 kA Cat.No. 4 077 00	1P+N MCB C16 10 kA Cat.No. 4 077 00	1P+N MCB C16 10 kA Cat.No. 4 077 00
Casing	Zero-U aluminium	Zero-U aluminium	Zero-U aluminium	Zero-U aluminium	Zero-U aluminium	Zero-U aluminium
Fixings (included)	2 button + 2 standard brackets, 2 Minkels brackets + 2 screws					

\*\* Maximum capacity of terminal block 6 mm<sup>2</sup>

Zero-U PDUs (continued)

	<b>6 468 57</b>	<b>6 468 59</b>	<b>6 468 60</b>	<b>6 468 61</b>	<b>6 468 70</b>	<b>6 469 00</b>
Number of phases	1	1	1	1	3	1
Input voltage	230 V	230 V	230 V	230 V	400 V	230 V
Input current	32 A	32 A	32 A	32 A	16 A	16 A
Maximum power	7.4kW	7.4kW	7.4kW	7.4kW	11kW	3.7kW
Connection method	Cord	Cord	Terminal block**	Cord	Cord	Cord
Cable length	3 m	3 m		3 m	3 m	3 m
Cable material	Rubber HO7RNF	Rubber HO7RNF		Rubber HO7RNF	Rubber HO7RNF	PVC HO5VVF
Cable cross-section	3G 4	3G 4		3G 4	5G 2.5	3G 1.5
Plug type	IEC 60309 32 A 2P+E	IEC 60309 32 A 2P+E		IEC 60309 32 A 2P+E	IEC 60309 16 A 3P+N+E	Schuko/UTE
Cable retention method	Cable clamp + rotative system	Cable clamp + rotative system	Cable clamp + rotative system	Cable clamp + rotative system	Cable clamp + rotative system	Cable clamp + rotative system
Number and type of outlets*	24 C13 with locking	24 German/Italian	20 C13 + 4 C19 with locking	20 C13 + 4 C19 with locking	18 C13 + 6 C19 with locking	12 German
Outlet colour	Black	Black	Black	Black	Black	Black
Angle of outlets	90°	90°	90°	90°	90°	55°
Number of circuits per phase	2	2	2	2	1	1
Identification of circuits (colour-code)	Blue/Red	Blue/Red	Blue/Red	Blue/Red		
Additional functions	1P+N MCB C16 10 kA Cat.No. 4 077 00	1P+N MCB C16 10 kA Cat.No. 4 077 00	1P+N MCB C16 10 kA Cat.No. 4 077 00	1P+N MCB C16 10 kA Cat.No. 4 077 00	1P MCB C16 10 kA Cat.No. 4 076 54	Surge protection module
Casing	Zero-U aluminium	Zero-U aluminium	Zero-U aluminium	Zero-U aluminium	Zero-U aluminium	Zero-U aluminium
Fixings (included)	2 button + 2 standard brackets, 2 Minkels brackets + 2 screws					

\*\* Maximum capacity of terminal block 6mm<sup>2</sup>

Zero-U PDUs (continued)

	<b>6 469 01</b>	<b>6 469 02</b>
Number of phases	1	3
Input voltage	230 V	400 V
Input current	16 A	32 A
Maximum power	3.7kW	22kW
Connection method	Cord	Cord
Cable length	3 m	3 m
Cable material	PVC H05VVF	Rubber H07RNF
Cable cross-section	3G 1.5	5G 4
Plug type	Schuko/UTE	IEC 60309 32 A 3P+N+E
Cable retention method	Cable clamp + rotative system	Cable clamp + rotative system
Number and type of outlets*	14 German	24 C13 + 12 C19 with locking
Outlet colour	Black	Black
Angle of outlets	55°	90°
Number of circuits per phase	1	2
Identification of circuits (colour-code)		Blue/Red
Additional functions	Voltage presence indicator	1P MCB C16 10 kA Cat.No. 4 076 70 Voltage presence indicator
Casing	Zero-U aluminium	
Fixings (included)	2 button + 2 standard brackets, 2 Minkels brackets + 2 screws	

\*\* Maximum capacity of terminal block 6mm<sup>2</sup>

■ 2.2 Customized products

Legrand PDUs can be delivered with custom configurations to meet specific customer requirements. Contact your local sales representative to discuss your requirements.

↓ CONFIGURATION EXAMPLES



Example:  
19" PDU 1U with 2 x 2P+E French/Belgian standard outlets, 1 C19 socket and 6 C13 sockets.  
Supplied with 3 m cable and C20 plug

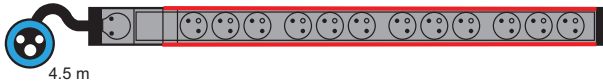

Example:  
Zero-U PDU with 12 2P+E French/Belgian standard outlets.  
Red strips for PDU identification purposes. Supplied with rotative cable entry, 4.5 m cable and IEC 60309 16 A plug

3. FUNCTIONS

■ 3.1 Outlets

Legrand PDUs can be equipped with outlets of different standards.

C13 with cord locking system

2P+E 10 A  
Outlet recess at 90° angle  
Conforms to standard IEC 60320-2-2

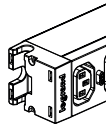

C19 with cord locking system

2P+E 16 A  
Socket recess at 90° angle  
Conforms to standard IEC 60320-2-2

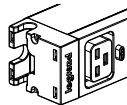

Cord locking system on C13/C19 sockets

The cord is locked mechanically into the outlet to prevent any unintended disconnection (caused by maintenance, vibrations, etc.).

Pull-out force > 100 N

This universal solution is compatible with all standard cords available on the market.

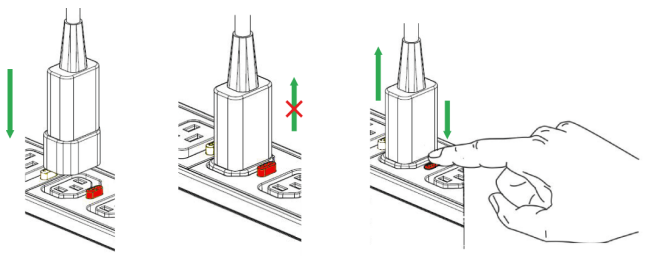

French-Belgian

2P+E 16 A  
Terminals equipped with protective shutters  
Outlet recess at 55° angle  
Conforms to standard IEC 60320-2-2

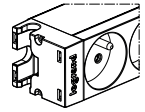

German

2P+E 16 A  
Terminals equipped with protective shutters  
Outlet recess at 55° angle  
Conforms to standard IEC 60320-2-2

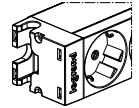

UK

2P+E 13 A  
Terminals equipped with protective shutters  
Outlet recess at 90° angle  
Conforms to standard IEC 60320-2-2

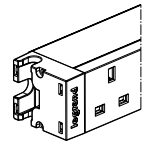

■ 3.2 LED switch

The LED switch is used to control the PDU power supply.  
A white LED is lit when the PDU sockets are supplied with power.  
16 A switch  
Transparent switch

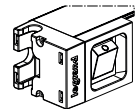

■ 3.3 Power indicator

A white LED on the power indicator shows that the product is supplied with power.

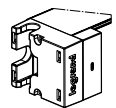





### ■ 3.5 Protection devices

Protection devices are integrated in all standard catalogue PDUs and customized PDUs.

#### - MCBs

For protecting equipment against short-circuits and overloads

407652	DX3 1P MCB 10 A 6000 A - 10 kA
407654	DX3 1P MCB 16 A 6000 A - 10 kA
409131	DX3 1P MCB 10 A 10000 A - 16k A
409133	DX3 1P MCB 16 A 10000 A - 16 kA
407698	DX3 1P+N MCB 10 A 6000 A - 10 kA
407700	DX3 1P+N MCB 16 A 6000 A - 10 kA
409150	DX3 1P+N MCB 10 A 10000 A - 16 kA
409152	DX3 1P+N MCB 16 A 10000 A - 16 kA

#### - RCBOs

For protecting equipment against short-circuits and overloads and protecting people against leakage currents

410704	RCBO 10 A ACTYPE 4500 A - 6 kA - 30 mA
410705	RCBO 16 A ACTYPE 4500 A - 6 kA - 30 mA
410752	RCBO 10 A HPI ACTYPE 4500 A - 6 kA - 30 mA
410753	RCBO 16 A HPI ACTYPE 4500 A - 6 kA - 30 mA

See section 2 "Equipment and performance" to see which protection device is integrated in the standard catalogue products.

MCBs and RCBOs are installed on a projecting DIN rail support to avoid unintended breaking. This support can be equipped with a transparent cover by special request.

1 or 2-module support depending on the catalogue number

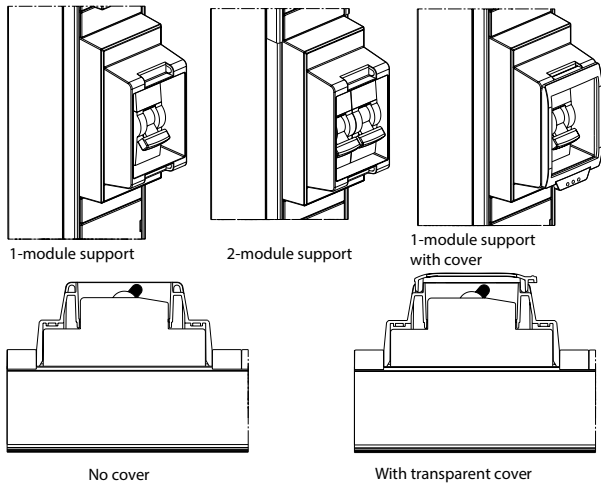

### ■ 3.6 Fuse (custom configured version)

For protecting equipment against short-circuits and overloads

Cartridge rating: 10 A and 16 A

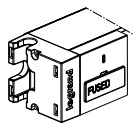

To replace the cartridge, use a screwdriver to lever open the compartment containing the fuse.

### ■ 3.7 Thermal overload breaker (custom configured version)

For protecting equipment against overloads

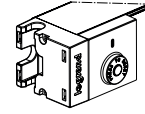

Reset: The LED is lit during operation. When there is an overload, the red button pops out of the module and the LED goes off. To reset the breaker, press the red button until it clicks back into position; the LED lights up again.

#### Characteristics :

- Rating: 10 and 16 Amps
- Dielectric Strength: 1500Vac 1 minute
- Interrupting Capacity: 1000A/125Vac 200A/250Vac
- Insulation Resistance: >500 M ohms
- Resettable Overload Capacity: 10 times rated current
- Reset Time: <60 sec
- Contact Endurance: 125VacX150% of rated current >500 times

#### Trip Time Curves

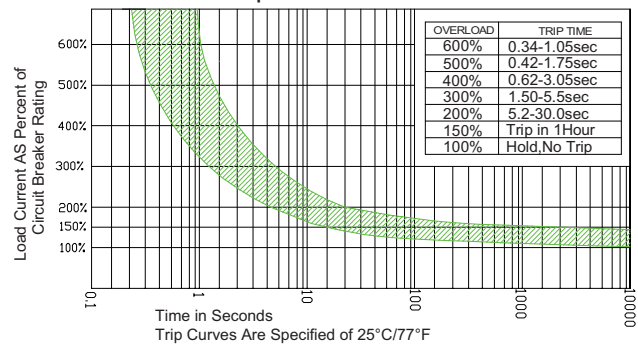

#### Ambient Temperature Correction Factor

Temperature	-5° C	0° C	10° C	20° C	25° C	30° C	40° C	50° C	60° C
Factor	X1.3	X1.2	X1.1	X1.05	X1.0	X0.9	X0.8	X0.7	X0.6

The time/current characteristic curve depends on the ambient temperature prevailing. In order to eliminate nuisance tripping, please multiply the breaker current ratings by the derating factor.

### 3.8 Colour-coding

The PDUs are colour-coded using coloured strips.

These strips clip onto the edge of the aluminium casing.

⚠ This solution is only compatible with Zero-U PDUs.

Extruded PVC plastic

Blue and red borders are available as standard, other colours are available on request.

## 2 applications:

- For identifying circuits: one colour per circuit, to match the same colour used on the circuit breaker



- For identifying the source: whole PDU in one colour identifies whether it is the primary or interruptible power source when there are 2 PDUs in the rack

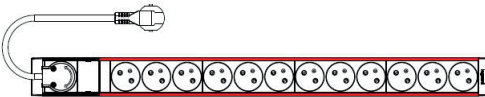

## 3.9 Locking caps

For locking out the use of a socket.

Require a key to unlock access.

Products comprise a set of 6 locking caps + 1 key.

Cat.No 646890: For French/Belgian, German and Italian standard sockets (P40)

Cat.No 646892: For UK standard sockets

Cat.No 646894: For C13 standard sockets

Cat.No 646895: For C19 standard sockets

ABS plastic

Light grey RAL 7035

## Operating principle

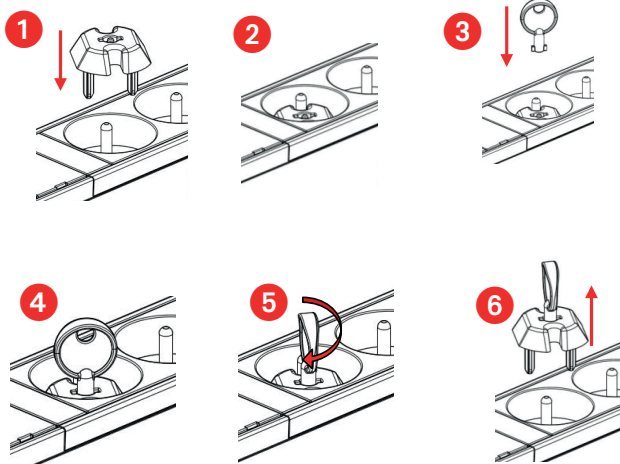

## 4. DIMENSIONS

### 4.1 10" PDU

All 10" catalogue numbers excluding 6 468 98

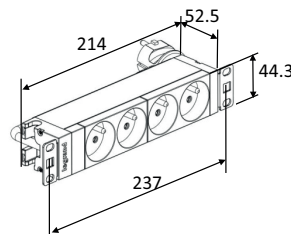

To be equipped catalogue number 6 468 98

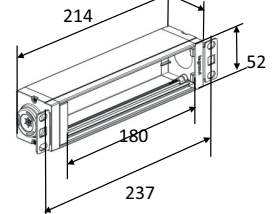

### 4.2 19" PDU

All 19" catalogue numbers excluding 6 468 99

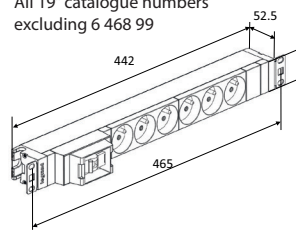

To be equipped catalogue number 6 468 99

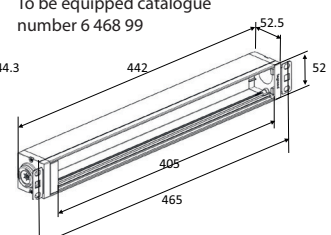

### 4.3 ZERO-U PDU

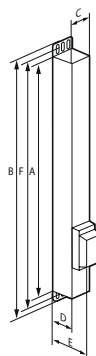

Cat. No	Height		Width C	Depth		Fixing centres (min.-max.) E <sup>1)</sup> F <sup>2)</sup>
	A	B <sup>1)</sup>		D	E <sup>2)</sup>	
6 468 50	1247	1291	52	52.5	87	1259 - 1279
6 468 51	1247	1291	52	52.5	87	1259 - 1279
6 468 52	1247	1291	52	52.5	87	1259 - 1279
6 468 53	1247	1291	52	52.5	87	1259 - 1279
6 468 54	1463	1507	52	52.5	87	1475 - 1495
6 468 56	1031	1075	52	52.5	87	1043 - 1063
6 468 57	1031	1075	52	52.5	87	1043 - 1063
6 468 60	1067	1111	52	52.5	87	1079 - 1099
6 468 61	1067	1111	52	52.5	87	1079 - 1099
6 468 70	1340	1384	52	52.5	87	1352 - 1372
6 469 10	1100	1144	52	82.5	103	1112-1132
6 469 11	1100	1144	52	82.5	103	1112-1132
6 469 00	887	931	52	52.5	87	899 - 919
6 469 01	1004	1048	52	52.5	87	1016-1036
6 469 02	1936	1980	52	52.5	87	1948-11968

1: Total height with standard bracket (screw-fixing)  
2: Total depth at circuit breaker slot

## 5. INSTALLATION

### 5.1 TERMINATION

Depending on the configuration, the PDUs can be connected in different ways.

#### 1) Supplied with power cord

See section 2 "Equipment and performance" to see which standard catalogue products have an integrated cord.

#### 2) Terminal block connection

Some products are supplied without a cable; they are designed to be wired on a terminal block.

See section 2 "Equipment and performance" to see which standard catalogue products have an integrated terminal block.

Example of terminal block connection for a Zero-U PDU with rotative cable entry

10" PDUs  
19" PDUs  
Zero-U PDUs

Cat. Nos: 6 468 00/01/05/06/07/09/10/11/12/13/14/15/18/19/2  
0/21/22/23/24/30/31/32/33/35/36/50/51/52/53/54/  
56/57/59/60/61/70/90/92/94/95/97/98/99,  
6 469 00/01/02/03/95/96/97/98/999

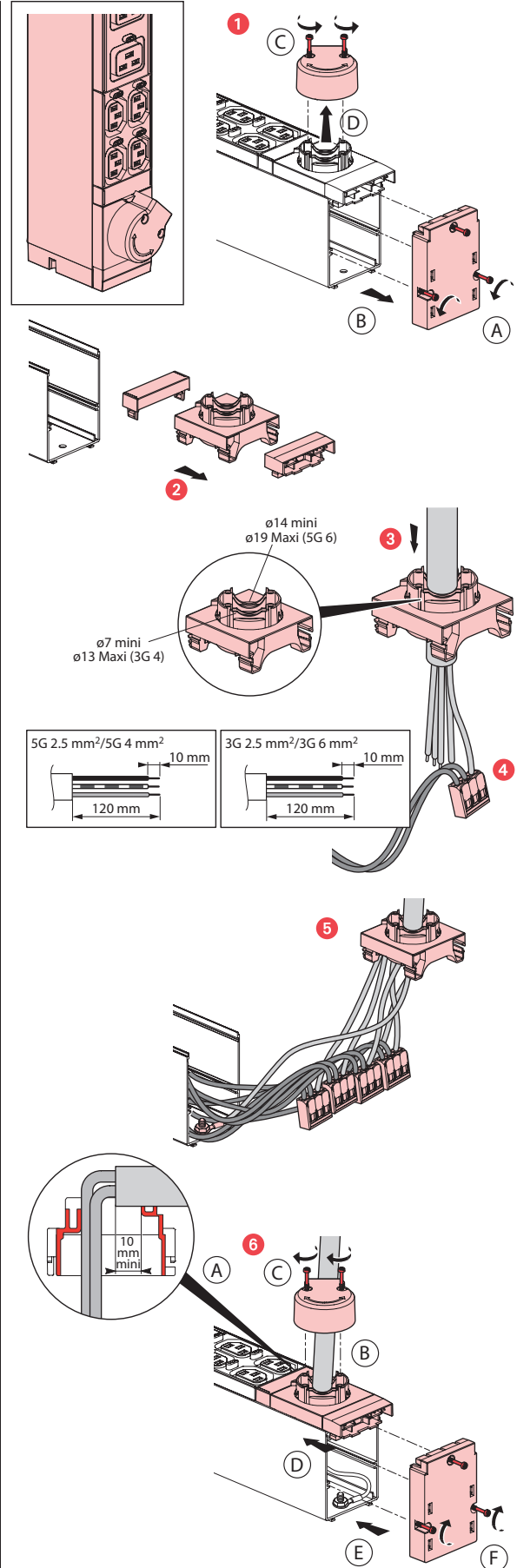
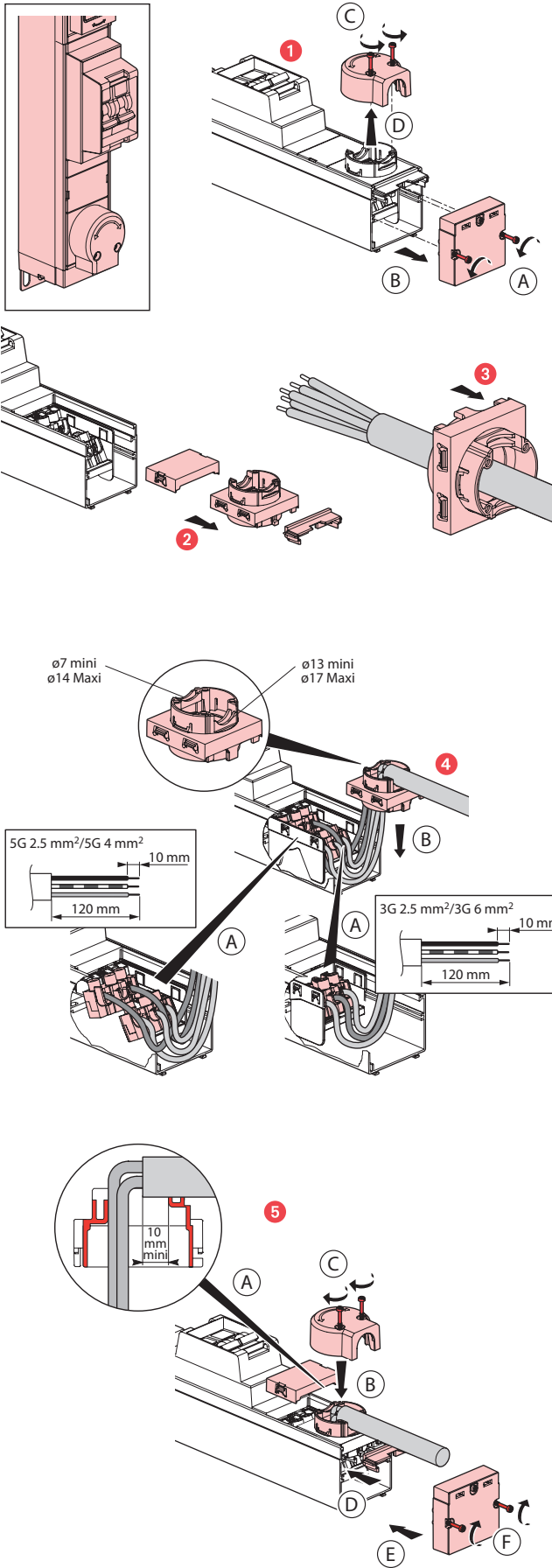

**3) Connection via fast connector or C20 connector (custom configured version)**

Connectors mounted on the front panel of the PDU. The PDU is powered via a separate cable that plugs into these connectors.

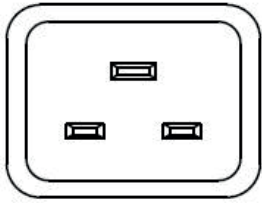

C20

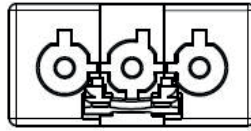

Wieland GST18

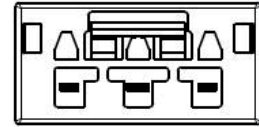

Wago

	C20	Wieland GST18	Wago
Type	Male	Female	Female
Nominal current	16 A	16 A	25 A
Voltage	250 VAC	250 VAC	250 VAC
IP	20	20	20

**4) Explanation of 19" cable entry, rotative cable input, input with cable gland**

The end piece on 19" PDUs integrates a cable guide.

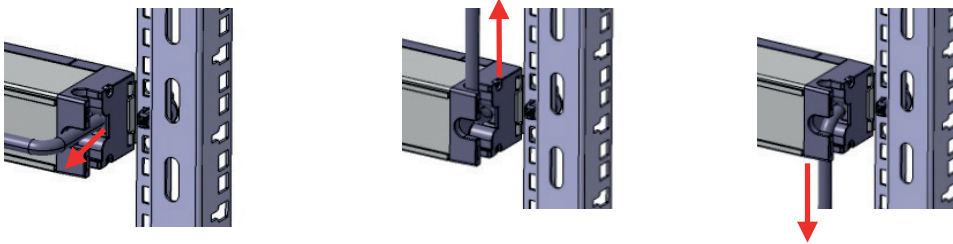

Zero-U PDUs integrate a rotative cable input (330°).

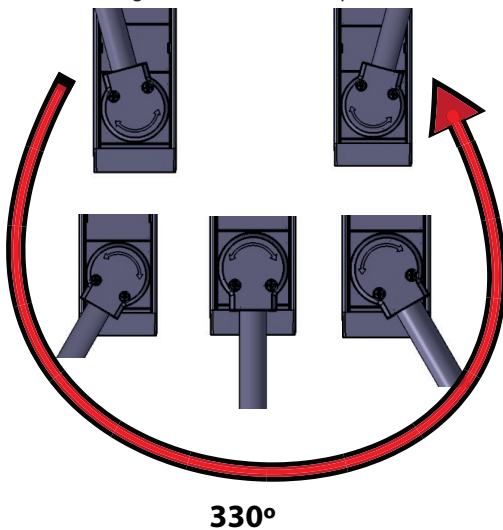

PDUs can be supplied with a cable input via cable gland by special request (input on front face or on the end).

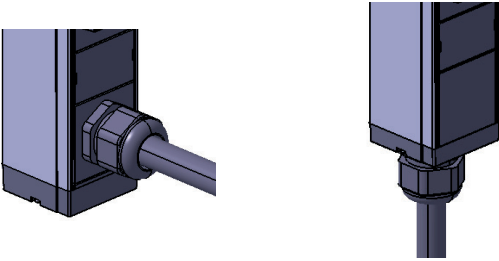

## 5.2 MOUNTING SOLUTIONS

### 1) 10" and 19"

Horizontal mounting with snap-on fixing (for square holes 9.5 x 9.5).

Snap-on fixing system included

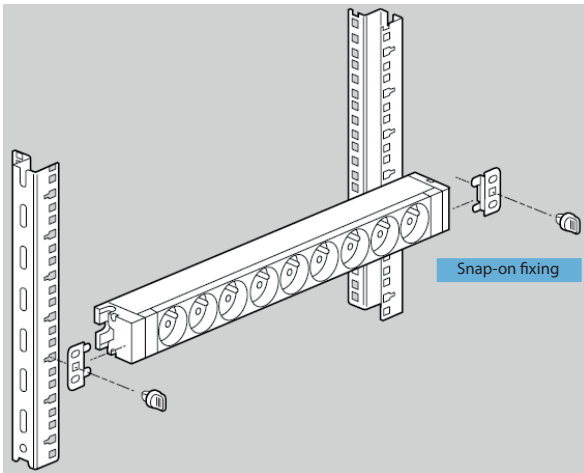

Vertical mounting possible by turning the fixing brackets round and positioning them on the rear of the unit.

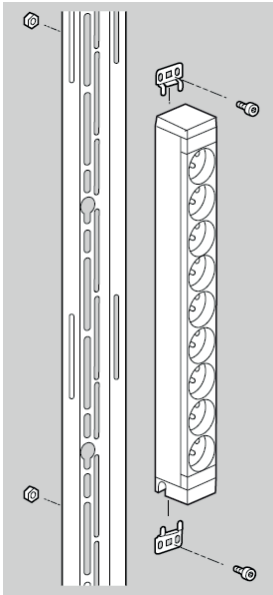

Mounting bracket dimensions

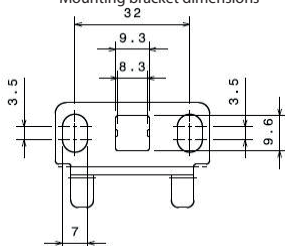

**2) Zero-U**

Zero-U PDUs are designed for vertical installation and supplied with 2 sets of fixing accessories:

- 2 button: for screwless fixing. The height of the fixing centre can be set at any point along the full height of the PDU by sliding the button slots into the groove on the rear of the PDU. Tightened using a screwdriver.

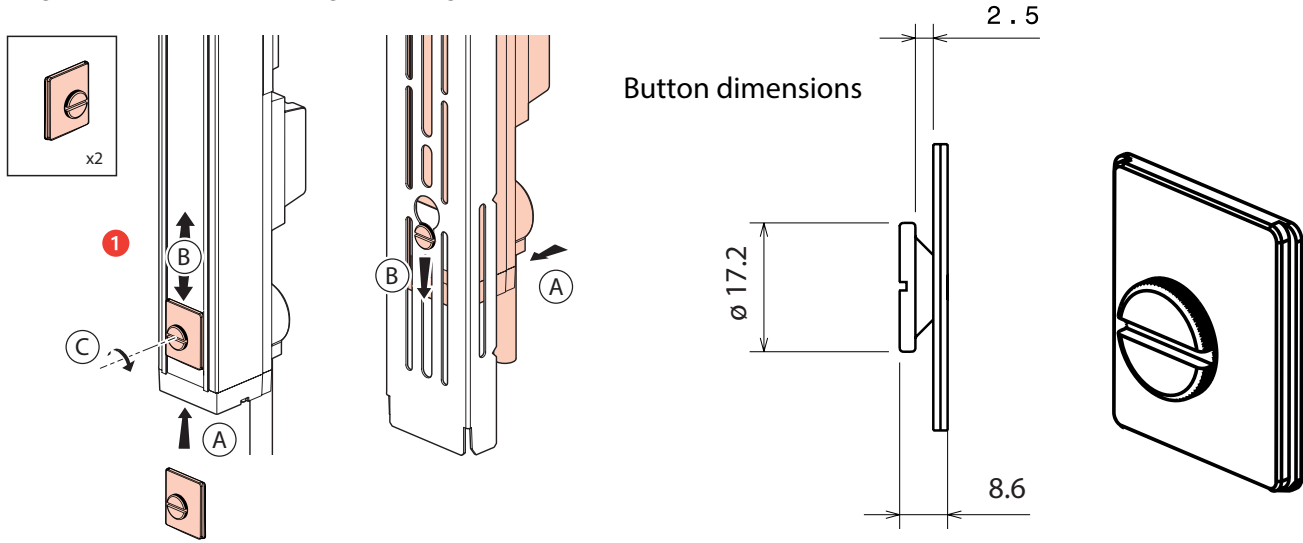

- 2 standard fixing brackets: for screw-fixing (screws not included)

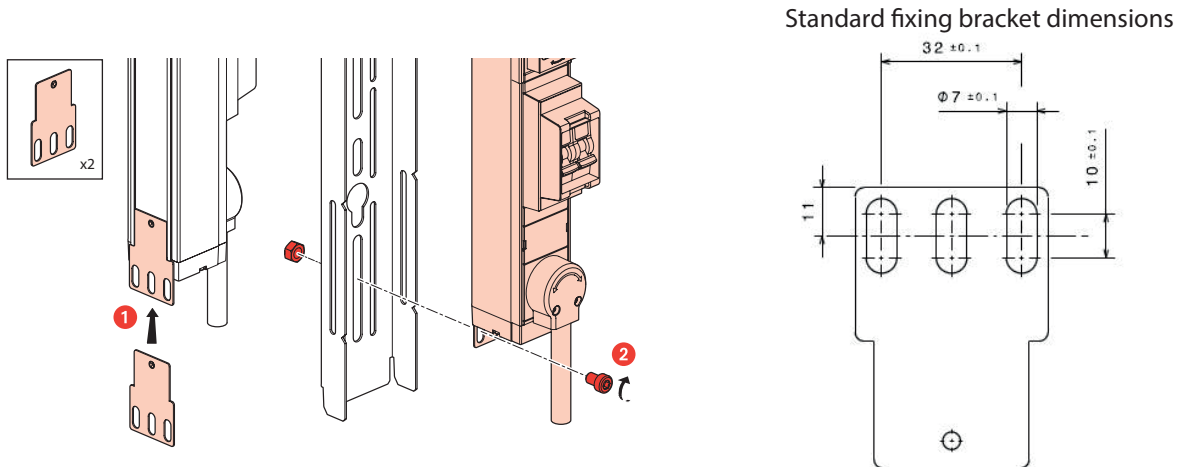

- 2 Minkels brackets + 2 screws

