

19421900	<b>DATA SHEET</b>	
Valid from: 09.09.2022	<b>EPIC® H-A 3 AGSV</b>	

## Description

- Compact housing for power supply in the smallest place.

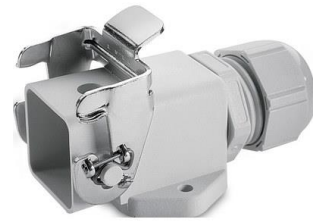

## General Characteristics

Series	H-A 3
Version	Panel mount base, angled
Locking	Single lever
Cable entry	1x lateral, see table
Cable gland	See table
Protection (DIN EN 60529)	IP 65 (latched)
Protection (NEMA 250, UL50E)	4, 12 (latched)
Temperature Range	-40°C to +100°C, short term up to +125°C

## Materials / Surfaces

Housing	PA
Locking	Steel, zinc-plated
Sealing	NBR
Pressure screw	PA
Pressure washer	Steel, zinc-plated
Sealing ring	NBR (Pg 11), CR (M20)
Flammability Class according to UL94	HB

## Approvals

VDE-Approval, VDE-REG.-Nr.	B437
UL-Approval, E-File-Number	E75770

## Standard

Safety Standard	DIN EN 60529
-----------------	--------------

## Versions

Article number	Article description	Cable entry	Cable gland	Color
10424000	EPIC® H-A 3 AGSV 11 ZW	Pg 11	Gland body	Grey (RAL 7035)
10424200	EPIC® H-A 3 AGSV 11 KPL	6.5 – 12 mm	Yes	Grey (RAL 7035)
19421900	EPIC® H-A 3 AGSV M20 KPL	6 – 13 mm	Yes	Grey (RAL 7035)

Creator: BEGE1/PDP Released: IVSE1/PDP	Document: DB19421900EN Version: 02	Page 1 of 2
---	---------------------------------------	-------------

19421900	<b>DATA SHEET</b>	
Valid from: 09.09.2022	<b>EPIC® H-A 3 AGSV</b>	

### Technical Drawings

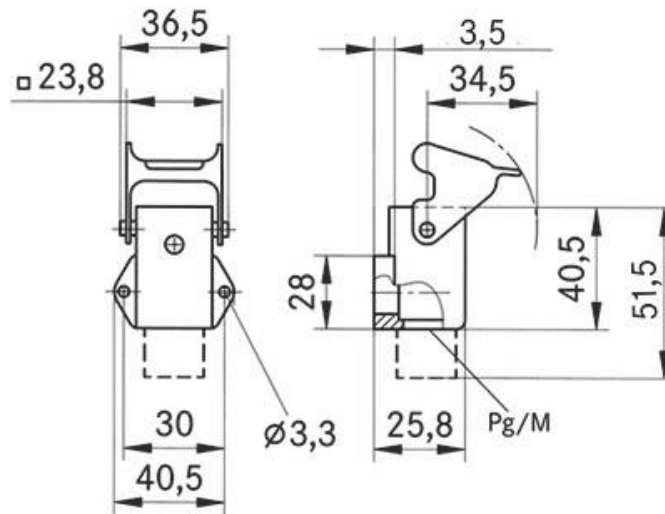

Industrial machinery and plant engineering



Mechanical resistance



Robust



Waterproof

### Application range

Machine and equipment manufacturing, control engineering, electronic laboratory

### Remark

Photographs are not to scale and do not represent detailed images of the respective products.

Creator: BEGE1/PDP Released: IVSE1/PDP	Document: DB19421900EN Version: 02	Page 2 of 2
---	---------------------------------------	-------------