

22260837	DATA SHEET	
Valid from: 12.09.2019	AB-C4-M12MS-(L*)PVC-M12FA	

Product description

Sensor/actuator cable, 4-pos., PVC black, straight plug M12 on angled socket M12.



Product variations

Article number	Article description	Length (L*) [m]
22260837	AB-C4-M12MS-1,0PVC-M12FA	1
22260832	AB-C4-M12MS-2,0PVC-M12FA	2
22260830	AB-C4-M12MS-3,0PVC-M12FA	3
22260831	AB-C4-M12MS-4,0PVC-M12FA	4
22260705	AB-C4-M12MS-5,0PVC-M12FA	5
22260835	AB-C4-M12MS-6,0PVC-M12FA	6
22260707	AB-C4-M12MS-7,0PVC-M12FA	7
22260834	AB-C4-M12MS-8,0PVC-M12FA	8
22260708	AB-C4-M12MS-9,0PVC-M12FA	9
22260833	AB-C4-M12MS-10,0PVC-M12FA	10

This datasheet is also valid for other length configurations. Other lengths upon request.

M12 connector

General properties

Coding	A
Protection degree	IP65/IP67/IP68
Number of contacts	4
Ambient temperature	-25 °C to +90 °C (-13 °F to +194 °F)
Rated voltage	250 V
Rated current	4 A
Insulation resistance	≥ 100 MΩ
Contact resistance	≤ 5 mΩ
Overvoltage category	II
Pollution degree	3
Tightening torque	0.4 Nm
Mating cycles	100

Materials

Contact carrier	TPU GF
Contact carrier, Inflammability class acc. to UL 94	HB
Material, contacts	CuSn
Contact surface	Ni/Au
Material, grip body	TPU
Material, knurl	zinc die-cast, nickel-plated
Material, sealing	NBR

Creator: MANA2/PDP Released: IVSE1/PDP	Document: DB22260837EN Version: 05	Page 1 of 3
---	---------------------------------------	-------------

22260837	DATA SHEET	
Valid from: 12.09.2019	AB-C4-M12MS-(L*)PVC-M12FA	

Cable

Signal line, construction	19 x 0.15 mm
Signal line, AWG	22
Conductor, material	stranded of bare copper wire
Conductor, cross-section	0.34 mm ²
Number of cores	4
Core identification code	brown (1), white (2), blue (3), black (4)
Outer diameter, core insulation	1.26 mm
Core insulation, material	PVC
Outer sheath	PVC
Outer sheath, colour	black similar to RAL 9005
Outer diameter, cable	4.7 mm
Ambient temperature, fixed installation	-40 °C to +80 °C (-40 °F to +184 °F)
Ambient temperature, flexing	-25 °C to +80 °C (-13 °F to +184 °F)
Minimum bending radius, fixed installation	5 x cable diameter
Minimum bending radius, flexing	10 x cable diameter
Nominal voltage	≤ 300 V
Test voltage	≥ 3000 V
Flame retardance	flame retardant acc. to UL-Style 2464

Standards/Approvals

Product standard, M12 connector	IEC 61076-2-101
UL-listed, E-File	E249137

Creator: MANA2/PDP Released: IVSE1/PDP	Document: DB22260837EN Version: 05	Page 2 of 3
---	---------------------------------------	-------------

22260837	DATA SHEET	
Valid from: 12.09.2019	AB-C4-M12MS-(L*)PVC-M12FA	

Drawings

Dimensioned drawing, M12 plug

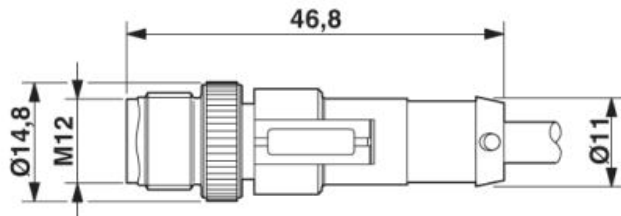

Dimensioned drawing, M12 socket

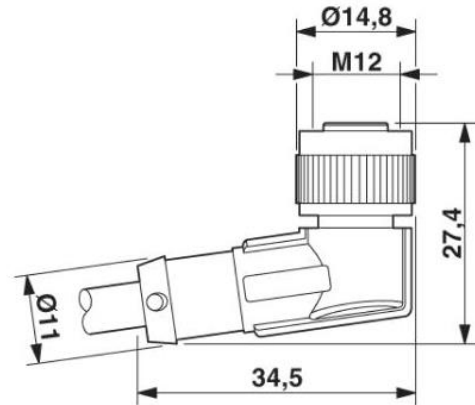

Pin assignment

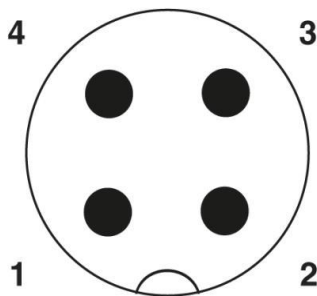

Pin assignment

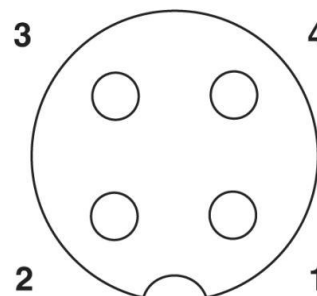

Cable

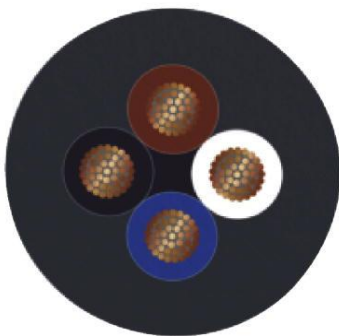

Core identification code: brown (1), white (2), blue (3), black (4)

Wiring diagram

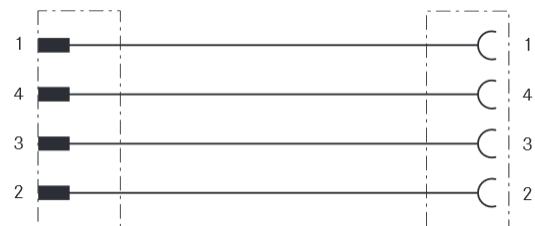

Application range

Automation, industrial machinery and plant engineering

Note

Photographs are not true to scale and do not represent detailed images of the respective products.

Creator: MANA2/PDP Released: IVSE1/PDP	Document: DB22260837EN Version: 05	Page 3 of 3
---	---------------------------------------	-------------