

22260586	DATA SHEET	
Valid from: 18.11.2019	AB-C3-2,0PUR-BI-1L-S	

Description

- Sensor/actuator cable with LED, PUR halogen-free
- Free wire end, 3-pol, to valve plug BI (11 mm)



General characteristics

Number of pins	3
Ambient temperature (operation)	-20 to +85 °C (-4°F to 185°F) (valve plug) -40 to +80 °C (-40°F to 176°F) (cable fixed installation) -20 to +80 °C (-4°F to 176°F) (cable flexible)
Degree of protection	IP 65 / IP 67
Cable length of the free cable end	50 mm
Central screw valve plug	M3 x 29

Variation

Article	Description	Length [m]
22260586	AB-C3-2,0PUR-BI-1L-S	2,0
22260580	AB-C3-5,0PUR-BI-1L-S	5,0
22260581	AB-C3-10,0PUR-BI-1L-S	10,0

Additional note

This datasheet is also valid for other length configurations. Other lengths upon request.

Electrical properties

Rated voltage	24 V
Rated current at 40 °C	4 A
Overvoltage category	III
Pollution degree	3

Mechanical properties

Plug

Inflammability class according to UL 94	V0
Contact valve plug	CuSn
Contact surface valve plug	Sn
Contact insert valve plug	PA 66
Housing valve plug	TPU
Seal	TPU (seal injected)
Tightening torque	0.6 Nm (valve plug connector)

Creator: ERTC1/PDP Released: IVSE1/PDP	Document: DB22260586EN Version: 05	Page 1 of 3
---	---------------------------------------	-------------

22260586	DATA SHEET	
Valid from: 18.11.2019	AB-C3-2,0PUR-BI-1L-S	

Line

Cable construction	3x AWG20/28
Conductor diameter including isolation	1.5 mm ± 0.05 mm (signal line)
Cable outer diameter	4.5 mm ± 0.2 mm
Core identification	Black 1, black 2, green / yellow
Sheath colour	Black grey RAL 7021
Bending radius	50 mm
Number of bending cycle	15000000
Traveling distance	0.9 m
Travel speed	5 m/s
Acceleration	30 m/s ²
Outer coating, material	PUR
Wire insulation, material	PP
Flame resistance	Acc. DIN VDE 0482 Acc. DIN EN 50265-2-1
Halogen-free	Acc. DIN VDE 0472 part 815

Standards / Approvals

Valve connectors	EN 175301-803
------------------	---------------

Technical drawing

Wire cross section

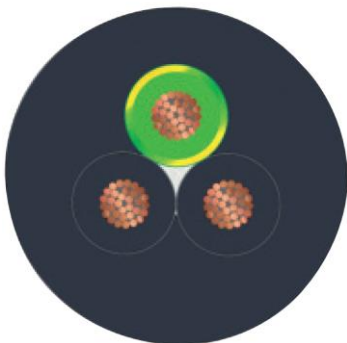

Drawing

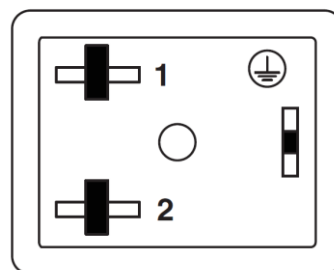

Pin assignment valve plug, design BI

Creator: ERTC1/PDP Released: IVSE1/PDP	Document: DB22260586EN Version: 05	Page 2 of 3
---	---------------------------------------	-------------

22260586	DATA SHEET	
Valid from: 18.11.2019	AB-C3-2,0PUR-BI-1L-S	

Dimensional drawing

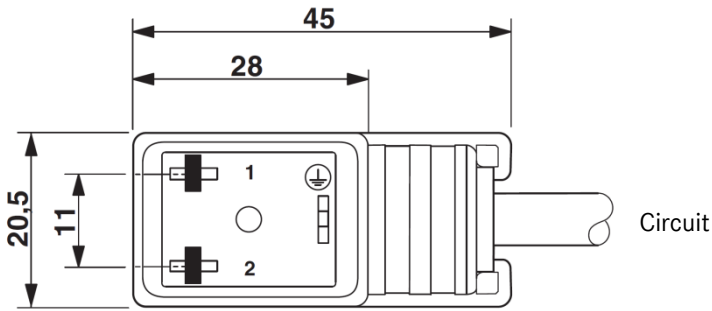

valve plug, design BI

Dimensional drawing

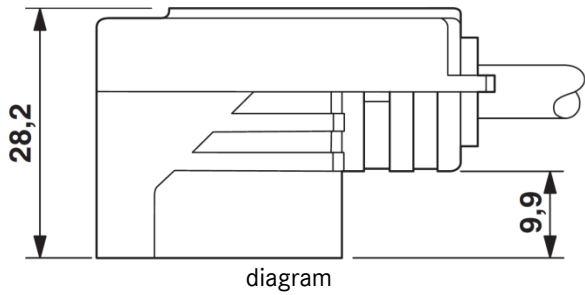

diagram

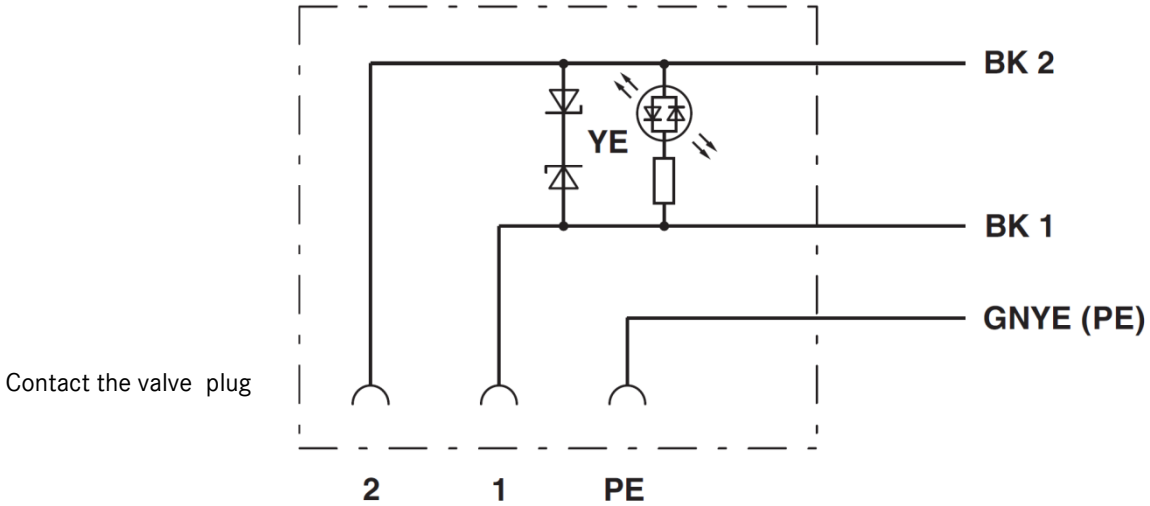

Contact the valve plug

Application range

Automation, industrial machinery and plant engineering

Note

Photographs are not true to scale and do not represent detailed images of the respective products.

Creator: ERTC1/PDP Released: IVSE1/PDP	Document: DB22260586EN Version: 05	Page 3 of 3
---	---------------------------------------	-------------