

22260212	DATA SHEET	
Valid from: 09.11.2018	AB-C3-M8MS-1,0PUR-M8FA	

Sensor/actuator cable, 3-pin, black halogen-free PUR, straight M8 plug to angled M8 socket, cable length: 1.0 m



General data

Number of pins:	3
Protection rating:	IP65/IP67/IP68
Degree of soiling:	3
Status display:	no
Flammability class acc. to UL 94:	HB
Weight:	23 kg/km
Halogen-free:	In accordance with DIN VDE 0472 part 815
Surge voltage category:	II
Nominal voltage U_N :	60 V
Nominal current I_N :	3 A
Insulation resistance:	100 GOhm*km

Connector data

Coding:	A-Standard
Knurl material:	Zinc die-cast, nickel-plated
Gripping body material:	TPU, flame-retardant, self-extinguishing
Sealing material:	NBR
Contact surface material:	Ni/Au
Contact carrier material:	TPU GF
Contact resistance:	5 mΩ

Ambient temperature (operation):

min.	-25 °C
max.	90 °C

Conductor data

Cable abbreviation:	Li9Y11Y-HF
Cable types:	black, halogen-free PUR
Flame retardance:	In accordance with UL-Style 20549
Outer sheath colour:	black grey (RAL 7021)
Cable Ø:	4.4 mm
Conductor material:	Bare copper litz wire

Creator: PM	Document: DB22260212EN Version: 03	Page 1 of 3
-------------	---------------------------------------	-------------

22260212	DATA SHEET	
Valid from: 09.11.2018	AB-C3-M8MS-1,0PUR-M8FA	

Core insulation material: PP
 Core diameter including insulation: 1.15 mm
 Conductor cross-section: 0.25 mm²
 AWG signal line: 24
 Bending radius: 44 mm
 Max. bending cycles: 4000000

Ambient temperature (operation), cable, fixed installation:
 min. -40 °C
 max. 80 °C

Ambient temperature (operation), cable, flexible installation:
 min. -5 °C
 max. 80 °C

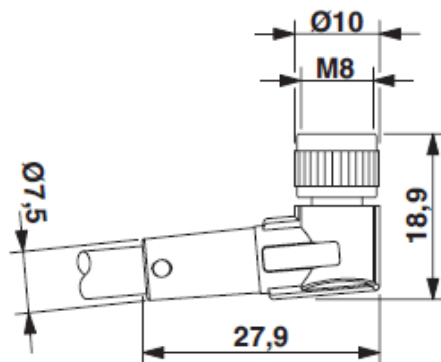
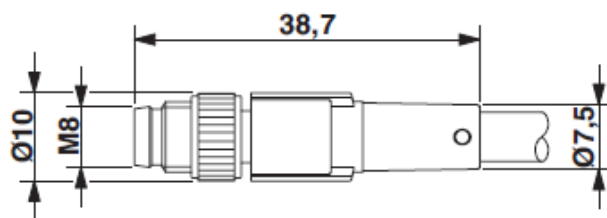

Creator: PM	Document: DB22260212EN Version: 03	Page 2 of 3
-------------	---------------------------------------	-------------

22260212	DATA SHEET	
Valid from: 09.11.2018	AB-C3-M8MS-1,0PUR-M8FA	

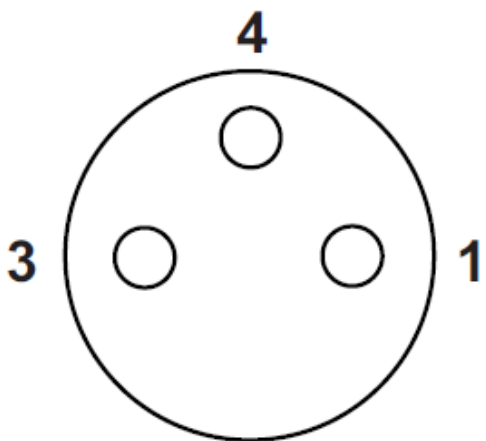
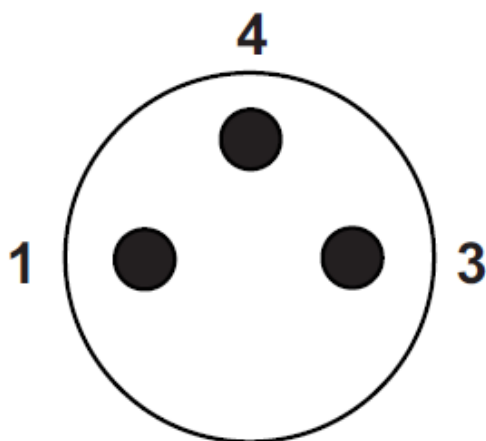
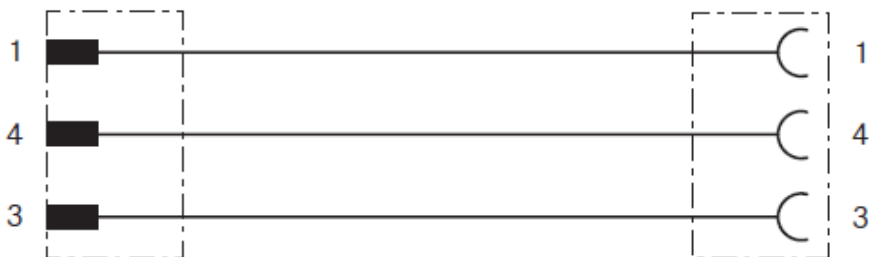

Note

Photographs are not true to scale and do not represent detailed images of the respective products.

Creator: PM	Document: DB22260212EN Version: 03	Page 3 of 3
-------------	---------------------------------------	-------------