

22260112	DATA SHEET	
Valid from: 17.09.2018	AB-C5-M12MS-PG9-0,5	

Description

- Sensor/Actuator flush-type plug, 5-pos., A-coded, M12
- Front/screw mounting with PG9 thread, with 0.5 m TPE litz wire, 5 x 0.34 mm²



General characteristics

Number of poles	5
Connection type	Fixed connection
Status indicator	No
Coding	A-standard
Degree of protection	IP 67
Inflammability class acc. to UL 94	V0
Ambient temperature (operation)	-25 to +90 °C (-13 to 194 °F) (cable fixed installation) -25 to +85 °C (-13 to 185 °F) (connector)

Electrical properties

Nominal voltage U _N	60 V
Nominal current I _N	4 A
Surge voltage category	II
Pollution degree	3
Insulation resistance	20 mΩ*km
Contact resistance	3 mΩ

Mechanical properties

Connector

Contact, material	CuZn
Contact surface, material	Au
Contact carrier, material	PA66 GF
Knurl, material	Brass (nickel-plated)
Sealing, material	NBR

Line

Cable type	TPE litz wire
Conductor, material	Tin plated copper litz wires
Core insulation, material	PE
Conductor diameter including insulation	1.2 mm
Conductor cross section	0.34 mm ²
AWG signal line	22

Creator: MOKO2/PDP Released: IVSE1/PDP	Document: DB22260112EN Version: 03	Page 1 of 2
---	---------------------------------------	-------------

22260112	DATA SHEET	
Valid from: 17.09.2018	AB-C5-M12MS-PG9-0,5	

Technical drawing

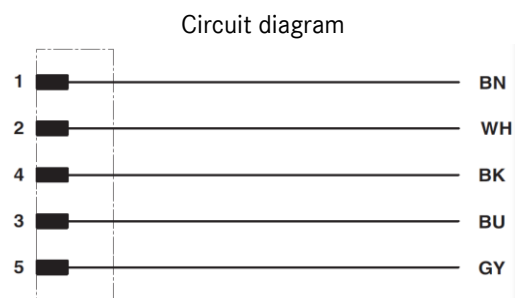
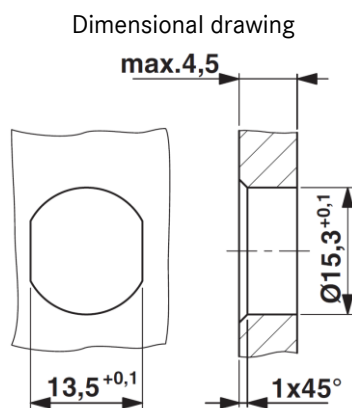
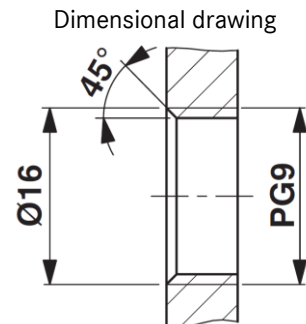
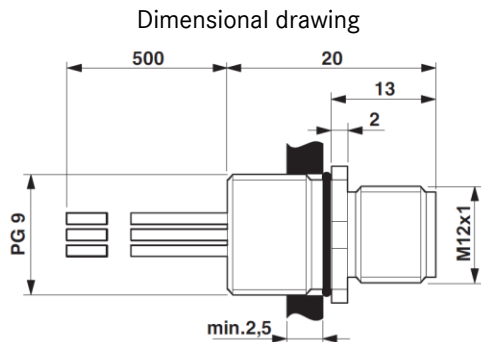

Application range

Connection of enclosures and cabinets

Note

Photographs are not true to scale and do not represent detailed images of the respective products.

Creator: MOKO2/PDP Released: IVSE1/PDP	Document: DB22260112EN Version: 03	Page 2 of 2
---	---------------------------------------	-------------