

22260004	DATA SHEET	
Valid from: 17.09.2018	AB-B8-M12L-16-C	

Description

- Sensor/actuator box
- Connection methods: quick locking and LED pluggable master cable connection and double-occupied slots
- slots: 8



Number of slots:	8
Nominal voltage U _N :	24 V DC
Max. current carrying capacity per path:	2 A
Total current:	1x10 A
Total rated current (for electrical isolation):	2x8 A
Connection type:	pluggable master cable connection
Current carrying capacity per slot:	4 A
Number of poles:	5
Degree of protection:	IP65/IP67/IP69K
Status display:	LEDs
Inflammability class acc. to UL 94:	V0
Contact surface material:	Gold-plated
Material, O-ring:	NBR
Material of the moulding mass:	PUR
Material of threaded sleeve:	Zinc die-cast
Material of threaded sleeve surface:	Nickel-plated
Tightening torque slot sensor/actuator cable:	0.4 Nm
Tightening torque screw plug:	0.4 Nm

Conductor data

Slot/position = Wire colour or connection:	1 / 4 (A) = 1 / 4
--------------------------------------------	-------------------

Creator: FELI1/PDP Released: IVSE1/PDP	Document: DB22260004EN Version: 04	Page 1 of 3
-------------------------------------------	---------------------------------------	-------------

22260004	DATA SHEET	
Valid from: 17.09.2018	AB-B8-M12L-16-C	

Technical drawing

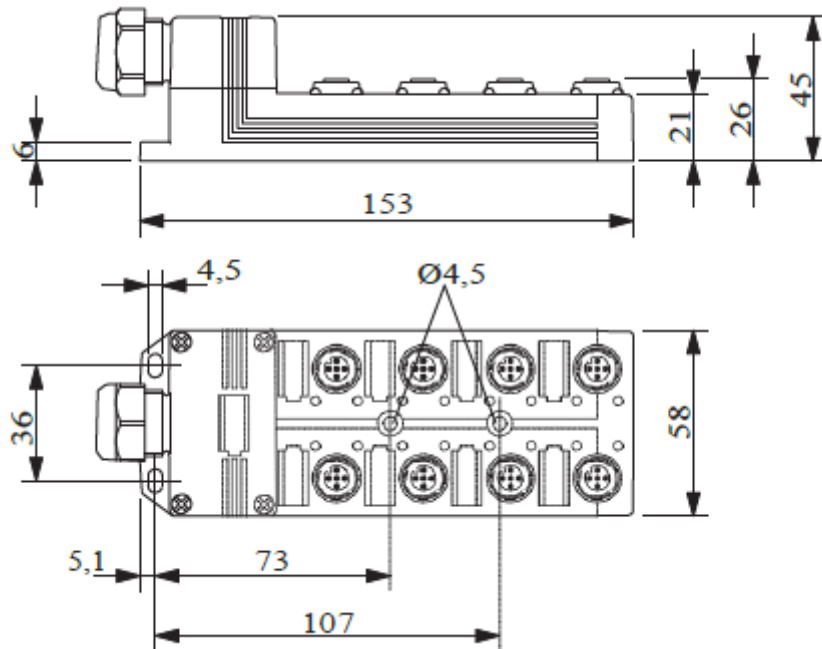

Circuit diagram

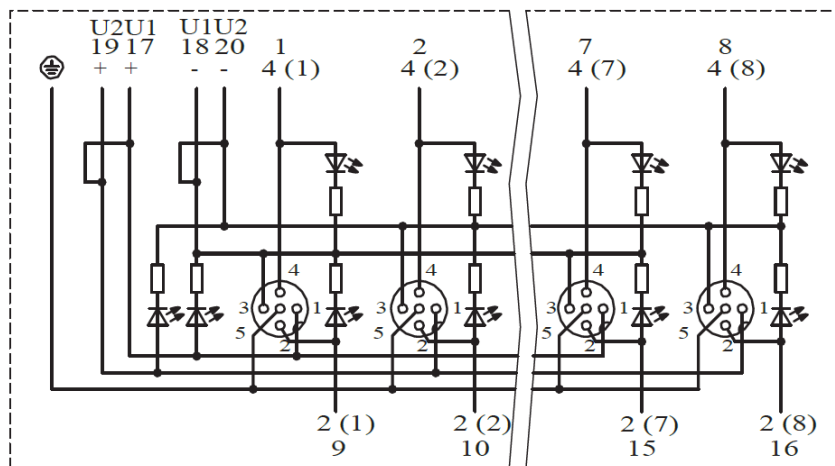

Example:

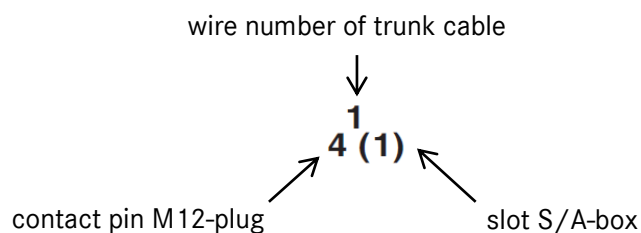

Creator: FELI1/PDP Released: IVSE1/PDP	Document: DB22260004EN Version: 04	Page 2 of 3
-------------------------------------------	---------------------------------------	-------------

Schema drawings

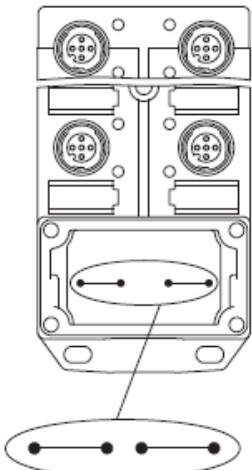
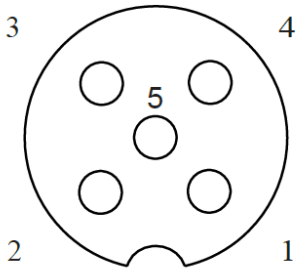

Potential U_{N1} and U_{N2} joint.
Potential order:
 $U_{N1} = U_{N2} =$ slots 1,2,3,4

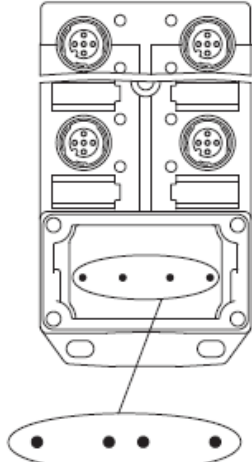

Potential separated. Potential order:
 $U_{N1} =$ slots 1, 3 and
 $U_{N2} =$ slots 2, 4

Pin assignment

Slot/ position = Wire colour or connection

- 1 / 4 (A) = 1 / 4
- 1 / 2 (B) = 1 / 2
- 2 / 4 (A) = 2 / 4
- 2 / 2 (B) = 2 / 2
- 3 / 4 (A) = 3 / 4
- 3 / 2 (B) = 3 / 2
- 4 / 4 (A) = 4 / 4
- 4 / 2 (B) = 4 / 2
- 5 / 4 (A) = 5 / 4
- 5 / 2 (B) = 5 / 2
- 6 / 4 (A) = 6 / 4
- 6 / 2 (B) = 6 / 2
- 7 / 4 (A) = 7 / 4
- 7 / 2 (B) = 7 / 2
- 8 / 4 (A) = 8 / 4
- 8 / 2 (B) = 8 / 2
- 1-8 / 1 (+ 24 V) = U_N
- 1-8 / 3 (0 V) = 0 V
- 1-8 / 5 (PE) = PE

Application range

Automation, industrial machinery and plant engineering

Note

Photographs are not true to scale and do not represent detailed images of the respective products.