

44423070	<b>DATA SHEET</b>	
Valid from: 17.09.2018	<b>EPIC® M17 POWER A1</b>	

### Description:

Device connector straight, front wall mounting  
 SPEEDCON-Lock, M17  
 Pin configuration: 3+PE, 5+PE, 6+PE; 7+PE, 3+PE+5  
 Contact type: male/female, crimp  
 Seal: O-Ring axial  
 Shielded: yes  
 Flange dimension: 21, 6 mm x 21, 6 mm



### Product variants:

Article Number	Type	Pin configuration	PU
44423075	female	3+PE	5 pieces
44423070	male	3+PE	5 pieces
44423076	female	5+PE	5 pieces
44423071	male	5+PE	5 pieces
44423077	female	6+PE	5 pieces
44423072	male	6+PE	5 pieces
44423078	female	7+PE	5 pieces
44423073	male	7+PE	5 pieces
44423079	female	3+PE+5	5 pieces
44423074	male	3+PE+5	5 pieces

### General Characteristics

Connector Type	Device connector
Pin configuration	3+PE; 5+PE; 6+PE; 7+PE; 3+PE+5
Connector locking system	Speedcon
Mounting type	front wall mounting: 4 x Ø 2,7 mm
Termination method	Crimp
upper temperature range	+ 125 °C
lower temperature range	- 40 °C
Material contact	CuZn (brass)
Contact surface	Au (Gold)
Material insert	PA
Material housing	Zinc die-casting, nickel-plated
Seal	FPM
Protection class	IP 67
Degree of soiling	3
Overvoltage category	III
Cycle of mechanical operation	>100

Creator: STKU3/PDP Released: IVSE1/PDP	Document: DE44423070EN Version: 01	Page 1 of 7
---	---------------------------------------	-------------

## Version 3+PE

### Electrical Characteristics:

Rated Voltage	630 V
Rated Impulse Voltage	6000 V
Rated Current (25°C)	20 A
Contact diameter	2 mm
Termination cross-section	0,25 mm <sup>2</sup> – 2,5 mm <sup>2</sup>

### Pin configuration:

Female

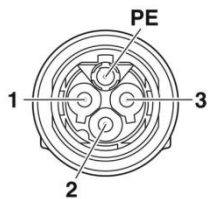

Male

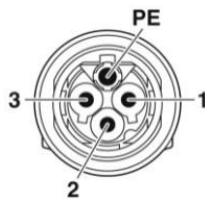

### Derating:

Diagramm

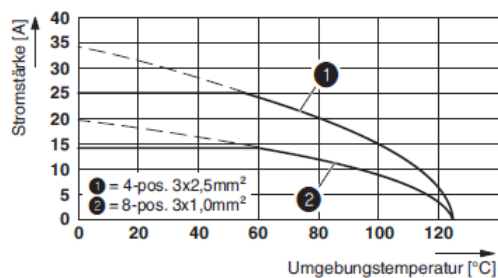

### Attenuation:

Diagramm

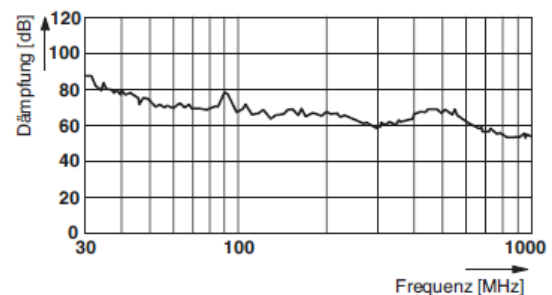

### Suitable female contacts (contacts order separately)



#### Lapp Art. No. Description

44423120:	Crimpkontakt, machined, Contact diameter: 2 mm, Crimp range: 0,25 mm <sup>2</sup> ...1 mm <sup>2</sup>
44423121:	Crimpkontakt, machined, Contact diameter: 2 mm, Crimp range: 1 mm <sup>2</sup> ...2,5 mm <sup>2</sup>

### Suitable male contacts (contacts order separately)



#### Lapp Art. No. Description

44423128:	Crimpkontakt, machined, Contact diameter: 2 mm, Crimp range: 0,25 mm <sup>2</sup> ...1 mm <sup>2</sup>
44423129:	Crimpkontakt, machined, Contact diameter: 2 mm, Crimp range: 1 mm <sup>2</sup> ...2,5 mm <sup>2</sup>

## Version 5+PE

### Electrical Characteristics:

Rated Voltage	630 V
Rated Impulse Voltage	6000 V
Rated Current (25°C)	14 A
Contact diameter	1 mm
Termination cross-section	0,06 mm <sup>2</sup> – 1,0 mm <sup>2</sup>

### Pin configuration:

Female



Male



### Derating:

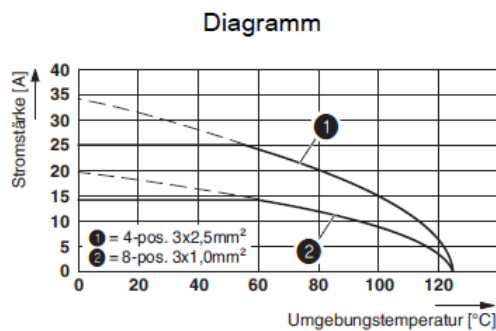

### Attenuation:

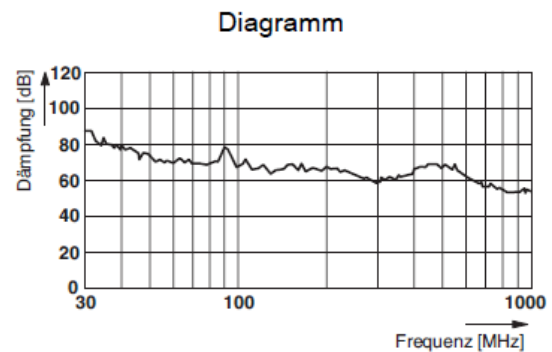

### Suitable female contacts (contacts order separately)



Lapp Art. No.	Description
44423122:	Crimpkontakt, machined, Contact diameter: 1 mm, Crimp range: 0,06 mm <sup>2</sup> ...0,25 mm <sup>2</sup>
44423123:	Crimpkontakt, machined, Contact diameter: 1 mm, Crimp range: 0,34 mm <sup>2</sup> ...0,5 mm <sup>2</sup>
44423124:	Crimpkontakt, machined, Contact diameter: 1 mm, Crimp range: 0,5 mm <sup>2</sup> ...1 mm <sup>2</sup>

### Suitable male contacts (contacts order separately)



Lapp Art. No.	Description
44423130:	Crimpkontakt, machined, Contact diameter: 1 mm, Crimp range: 0,06 mm <sup>2</sup> ...0,25 mm <sup>2</sup>
44423131:	Crimpkontakt, machined, Contact diameter: 1 mm, Crimp range: 0,34 mm <sup>2</sup> ...0,5 mm <sup>2</sup>
44423132:	Crimpkontakt, machined, Contact diameter: 1 mm, Crimp range: 0,5 mm <sup>2</sup> ...1 mm <sup>2</sup>

44423070	<b>DATA SHEET</b>	
Valid from: 17.09.2018	<b>EPIC® M17 POWER A1</b>	

## Version 6+PE

### Electrical Characteristics:

Rated Voltage	630 V
Rated Impulse Voltage	6000 V
Rated Current (25°C)	14 A
Contact diameter	1 mm
Termination cross-section	0,06 mm <sup>2</sup> – 1,0 mm <sup>2</sup>

### Pin configuration:

Female

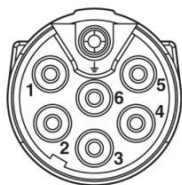

Male

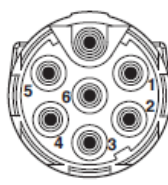

### Derating:

Diagramm

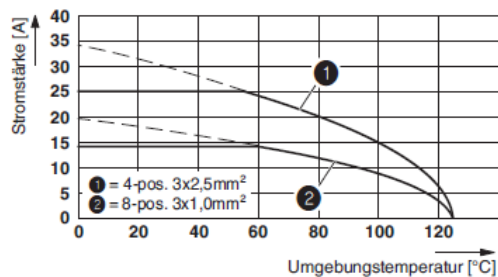

### Attenuation:

Diagramm

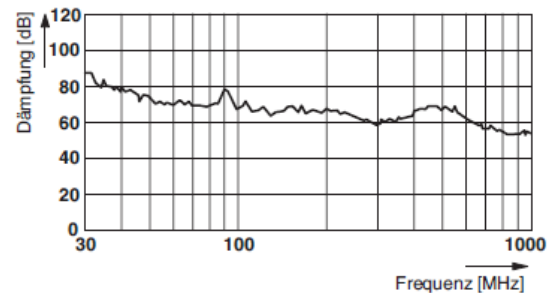

### Suitable female contacts (contacts order separately)



Lapp Art. No.	Description
44423122:	Crimpkontakt, machined, Contact diameter: 1 mm, Crimp range: 0,06 mm <sup>2</sup> ...0,25 mm <sup>2</sup>
44423123:	Crimpkontakt, machined, Contact diameter: 1 mm, Crimp range: 0,34 mm <sup>2</sup> ...0,5 mm <sup>2</sup>
44423124:	Crimpkontakt, machined, Contact diameter: 1 mm, Crimp range: 0,5 mm <sup>2</sup> ...1 mm <sup>2</sup>

### Suitable male contacts (contacts order separately)



Lapp Art. No.	Description
44423130:	Crimpkontakt, machined, Contact diameter: 1 mm, Crimp range: 0,06 mm <sup>2</sup> ...0,25 mm <sup>2</sup>
44423131:	Crimpkontakt, machined, Contact diameter: 1 mm, Crimp range: 0,34 mm <sup>2</sup> ...0,5 mm <sup>2</sup>
44423132:	Crimpkontakt, machined, Contact diameter: 1 mm, Crimp range: 0,5 mm <sup>2</sup> ...1 mm <sup>2</sup>

Creator: STKU3/PDP Released: IVSE1/PDP	Document: DE44423070EN Version: 01	Page 4 of 7
---	---------------------------------------	-------------

44423070	<b>DATA SHEET</b>	
Valid from: 17.09.2018	<b>EPIC® M17 POWER A1</b>	

## Version 7+PE

### Electrical Characteristics:

Rated Voltage	630 V
Rated Impulse Voltage	6000 V
Rated Current (25°C)	14 A
Contact diameter	1 mm
Termination cross-section	0,06 mm <sup>2</sup> – 1,0 mm <sup>2</sup>

### Pin configuration:

Female



Male

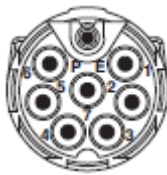

### Derating:

Diagramm

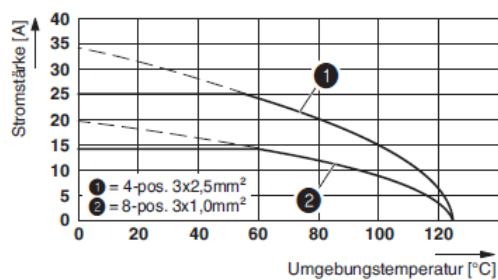

### Attenuation:

Diagramm

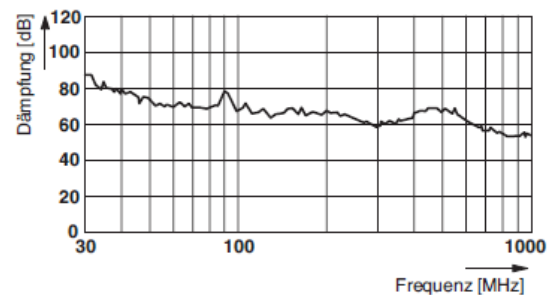

### Suitable female contacts (contacts order separately)



Lapp Art. No.	Description
44423122:	Crimpkontakt, machined, Contact diameter: 1 mm, Crimp range: 0,06 mm <sup>2</sup> ...0,25 mm <sup>2</sup>
44423123:	Crimpkontakt, machined, Contact diameter: 1 mm, Crimp range: 0,34 mm <sup>2</sup> ...0,5 mm <sup>2</sup>
44423124:	Crimpkontakt, machined, Contact diameter: 1 mm, Crimp range: 0,5 mm <sup>2</sup> ...1 mm <sup>2</sup>

### Suitable male contacts (contacts order separately)



Lapp Art. No.	Description
44423130:	Crimpkontakt, machined, Contact diameter: 1 mm, Crimp range: 0,06 mm <sup>2</sup> ...0,25 mm <sup>2</sup>
44423131:	Crimpkontakt, machined, Contact diameter: 1 mm, Crimp range: 0,34 mm <sup>2</sup> ...0,5 mm <sup>2</sup>
44423132:	Crimpkontakt, machined, Contact diameter: 1 mm, Crimp range: 0,5 mm <sup>2</sup> ...1 mm <sup>2</sup>

44423070	<b>DATA SHEET</b>	
Valid from: 17.09.2018	<b>EPIC® M17 POWER A1</b>	

## Version 3+PE+5

### Electrical Characteristics

Rated Voltage  
 Rated Impulse Voltage  
 Rated Current (25°C)  
 Contact diameter  
 Termination cross-section

### Power / Signal

630 V / 60 V  
 6000 V / 1500 V  
 14 A / 3, 6 A  
 1 mm / 0, 6 mm  
 0, 06 mm<sup>2</sup> – 1, 0 mm<sup>2</sup> / 0, 08 mm<sup>2</sup> – 0, 5 mm<sup>2</sup>

### Pin configuration:

Female

Male

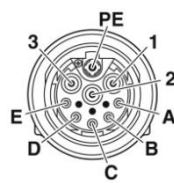
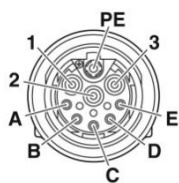

### Suitable female contacts (contacts order separately)



Lapp Art. No.	Description
44423122:	Crimpkontakt, machined, Contact diameter: 1 mm, Crimp range: 0, 06 mm <sup>2</sup> ...0, 25 mm <sup>2</sup>
44423123:	Crimpkontakt, machined, Contact diameter: 1 mm, Crimp range: 0, 34 mm <sup>2</sup> ...0, 5 mm <sup>2</sup>
44423124:	Crimpkontakt, machined, Contact diameter: 1 mm, Crimp range: 0, 5 mm <sup>2</sup> ...1 mm <sup>2</sup>
44423125:	Crimpkontakt, machined, Contact diameter: 0,6 mm, Crimp range: 0, 08 mm <sup>2</sup> ...0,25 mm <sup>2</sup>
44423126:	Crimpkontakt, machined, Contact diameter: 0, 6 mm, Crimp range: 0, 14 mm <sup>2</sup> ...0, 34 mm <sup>2</sup>
44423127:	Crimpkontakt, machined, Contact diameter: 0, 6 mm, Crimp range: 0, 34 mm <sup>2</sup> ...0, 5 mm <sup>2</sup>

### Suitable male contacts (contacts order separately)



Lapp Art. No.	Description
44423130:	Crimpkontakt, machined, Contact diameter: 1 mm, Crimp range: 0, 06 mm <sup>2</sup> ...0, 25 mm <sup>2</sup>
44423131:	Crimpkontakt, machined, Contact diameter: 1 mm, Crimp range: 0, 34 mm <sup>2</sup> ...0, 5 mm <sup>2</sup>
44423132:	Crimpkontakt, machined, Contact diameter: 1 mm, Crimp range: 0, 5 mm <sup>2</sup> ...1 mm <sup>2</sup>
44423133:	Crimpkontakt, machined, Contact diameter: 0, 6 mm, Crimp range: 0, 08 mm <sup>2</sup> ...0, 25 mm <sup>2</sup>
44423134:	Crimpkontakt, machined, Contact diameter: 0, 6 mm, Crimp range: 0, 14 mm <sup>2</sup> ...0, 34 mm <sup>2</sup>
44423135:	Crimpkontakt, machined, Contact diameter: 0, 6 mm, Crimp range: 0, 34 mm <sup>2</sup> ...0, 5 mm <sup>2</sup>

44423070	<b>DATA SHEET</b>	
Valid from: 17.09.2018	EPIC® M17 POWER A1	

**Technical Drawings and Dimensions:**

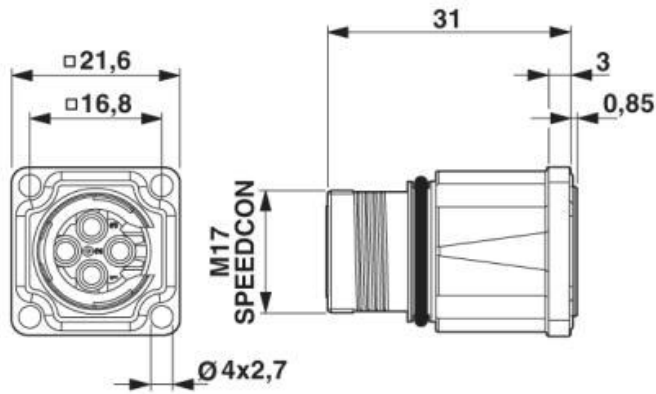

**Required holes and openings on the housing:**

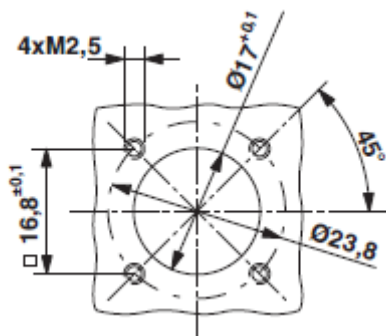

**Application range:**

Servo drives and servo assemblies  
Plant engineering, machinery manufacturing

**Remark:**

Photographs are not to scale and do not represent detailed images of the respective products.

Creator: STKU3/PDP Released: IVSE1/PDP	Document: DE44423070EN Version: 01	Page 7 of 7
---	---------------------------------------	-------------