

44420221	<b>DATA SHEET</b>	
Valid from: 21.10.2022	<b>EPIC® POWERLOCK A1 C</b>	

## Description

- Single-pin circular connector for mobile power distribution, electro motors and generators
- Resistant to mechanical influences in harsh environmental conditions
- Connectors in harmonised colours according to European standards
- Every colour has a different coding to prevent incorrect plugging



## General Characteristics

Series	A1 C
Version	panel-mount box, drain for contact with M12 threaded post
Rated voltage (V)	1000 V
Rated impulse voltage	8 kV
Rated current (A)	max. crimp 660 A
Contacts	Crimp termination: copper, silver-plated
Number of contacts	1
Short circuit withstand rating	16 kA for 1 second, 32 kA peak (300 mm <sup>2</sup> cable in 240 mm <sup>2</sup> contact)
Termination methods	Crimp termination: 35 - 300 mm <sup>2</sup>
Protection	IP 67 (maximum, dependant on cable gland used) IP 20 (unmated)
Cycle of mechanical operation	500
Temperature range	-25°C to +125°C
Degree of soiling	3

## Product Variations

Article- Number	Article	Fastening type	Pin configuration
<b>Type POWERLOCK A1, panel-mount box, drain for contact with M12 threaded post</b>			
44420221	POWERLOCK A1 PE/GN	Ø5,5mm (4x)	PE, Green
44420222	POWERLOCK A1 N/BL	Ø5,5mm (4x)	N, Blue
44420223	POWERLOCK A1 L1/BN	Ø5,5mm (4x)	L1, Brown
44420224	POWERLOCK A1 L2/BK	Ø5,5mm (4x)	L2, Black
44420225	POWERLOCK A1 L3/GY	Ø5,5mm (4x)	L3, Grey
<b>L1/red for direct current applications in conjunction with L2/black</b>			
44420316	POWERLOCK A1 L1/RD	Ø5,5mm (4x)	L1, Red

## Materials and Surfaces

Housing	PBT
Contact retention pin	PA

## Approvals

VDE-Approval, VDE-REG.-No.	D042
----------------------------	------

Creator: STKU3/PDP Released: IVSE1/PDP	Document: DB44420221EN Version: 05	Page 1 of 4
---	---------------------------------------	-------------

44420221	<b>DATA SHEET</b>	
Valid from: 21.10.2022	EPIC® POWERLOCK A1 C	

### Technical Drawings

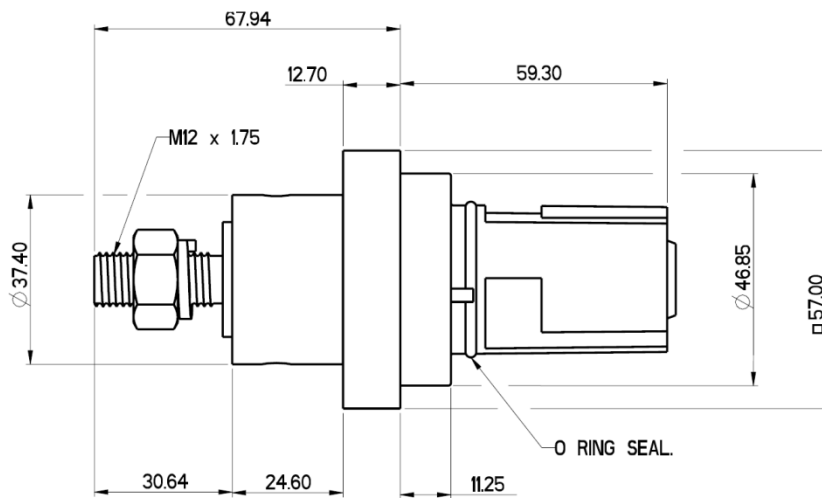



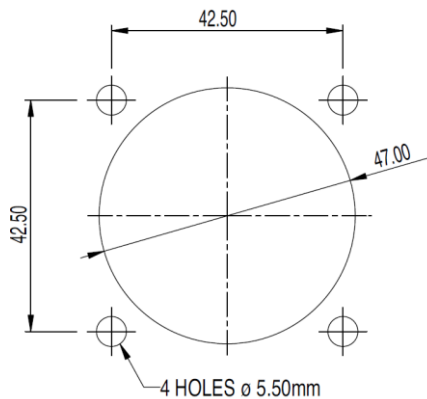



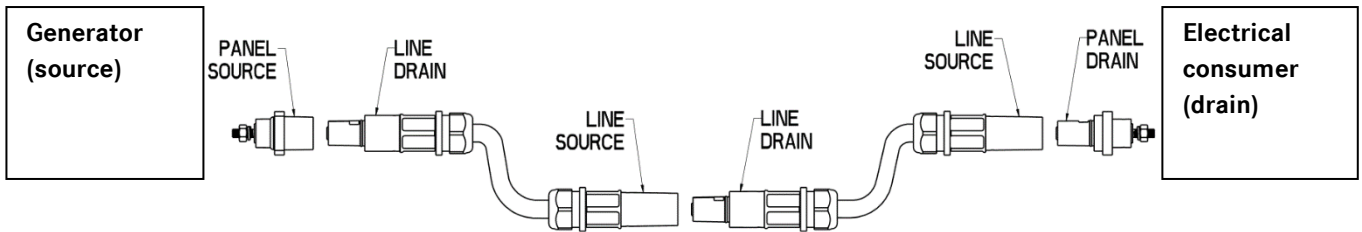

### Panel cutout



Creator: STKU3/PDP Released: IVSE1/PDP	Document: DB44420221EN Version: 05	Page 2 of 4
---	---------------------------------------	-------------

### System description



	Line connector	Panel mount connector	Crimp contact	Screw contact
Source	D6 	A6 		
Drain	F6 	A1 		

Step 1) Selection of housings

Step 2) Selection of SKINTOP® cable gland M40 for the housing (only cable connectors):

e.g. 3111250 (black), 53111450 (light grey), 53111050 (silver grey)

Step 3) Decision: 400 A / max. 120 mm<sup>2</sup> → Screw contacts

660 A / max. 240 mm<sup>2</sup> → Crimp contacts

**! Screw and crimp contacts are not allowed to be mixed!**

Step 4) Selection of contacts:

Crimp contacts

	35 mm <sup>2</sup>	50 mm <sup>2</sup>	70 mm <sup>2</sup>	95 mm <sup>2</sup>	120 mm <sup>2</sup>	150 mm <sup>2</sup>	185 mm <sup>2</sup>	240 mm <sup>2</sup> (NEW)
Quelle (Source)	44420290	44420291	44420292	44420236	44420238	44420257	44420239	44420324
Senke (Drain)	44420293	44420294	44420295	44420231	44420233	44420256	44420234	44420339

### Attention:

The effective copper cross-sections of cables are significantly smaller than the electrical values given.

**We always recommend qualifying the cable-contact combination.**

(From 120 mm<sup>2</sup> strong effects on the quality of the connection.

Example: 240 mm<sup>2</sup> cables fit better in 185 mm<sup>2</sup> contacts.)

Contacts with M12 thread (for cable lug Ø12 mm)

	M12-thread 660 A	M12-thread 400 A
Source	 44420261	 44420242
Drain	 44420260	 44420241

Tightening torque M12 nut: 27,5 Nm - 31,4 Nm

44420221	<b>DATA SHEET</b>	
Valid from: 21.10.2022	<b>EPIC® POWERLOCK A1 C</b>	



Robust



Reliability



Waterproof

### Application range

For renewable energy plants e.g. wind power  
 For mobile and stationary power distribution  
 For the connection of motors, transformers and generators  
 Light & sound technology

### Product features

Panel-mount base, straight entry  
 Contact fixing by contact retention pin, each pin can only be used once  
 Housing without contact, order contact separately

### Remark

Photographs are not to scale and do not represent detailed images of the respective products.

Creator: STKU3/PDP Released: IVSE1/PDP	Document: DB44420221EN Version: 05	Page 4 of 4
---	---------------------------------------	-------------