

53112700	DATA SHEET	
Valid from: 04.07.2022	SKINTOP® MS-M / MS-M XL / MSR-M ATEX	

The SKINTOP® MS-M / MS-M XL / MSR-M ATEX a nickel-plated brass cable gland with metric connecting thread, which combines high quality with regard to consistency and reliability, is especially designed for use with electrical equipment in areas with risk of explosion, especially in the chemical and petrochemical industry.

The cable glands SKINTOP® MS-M ATEX and SKINTOP® MSR-M ATEX are sufficient to the requirements of explosion protection to equipment-group II and equipment category 2G and 1D, type of protection Increased Safety "e" (DIN EN 60079-0, DIN EN 60079-7, DIN EN 60079-31, IEC 60079-0, IEC 60079-7, IEC 60079-31).



Components:

Gland body	Brass, nickel-plated
Cap nut	Brass, nickel-plated
Insert with lamellar cage	Polyamide (V2 acc. to UL94)
Sealing ring	CR
O-Ring	NBR

Technical features:

Connecting thread	M12x1,5 up to M63x1,5 acc. to EN 60423
Protection class / NEMA Type Rating	IP66, IP68 - 10 bar, test acc. to EN 60529 NEMA Type 1, Type 4X, Type 6 and Type 12
Temperature range	-30°C up to +90°C
Design	MS-M ATEX Standard MS-M XL ATEX with extended connecting thread MSR-M ATEX with reducing sealing ring

Approvals:



UL File Nr. E79903
(Test in acc. to UL514B)
UL-certification is only for MS-M / MSR-M ATEX (M12 - M63)

EC Type Examination Certification: IBExU 01 ATEX 1041x

IECEX Certificate: IECEX IBE 13.0026x

Category:

Equipment group II
Equipment category 2G and 1D

Norm references:



Creator: VACH1 /PDP Released: DAMU1/PDP	Document: DB53112700EN Version: 15	Page 1 of 2
--	---------------------------------------	-------------

53112700	DATA SHEET	
Valid from: 04.07.2022	SKINTOP® MS-M / MS-M XL / MSR-M ATEX	

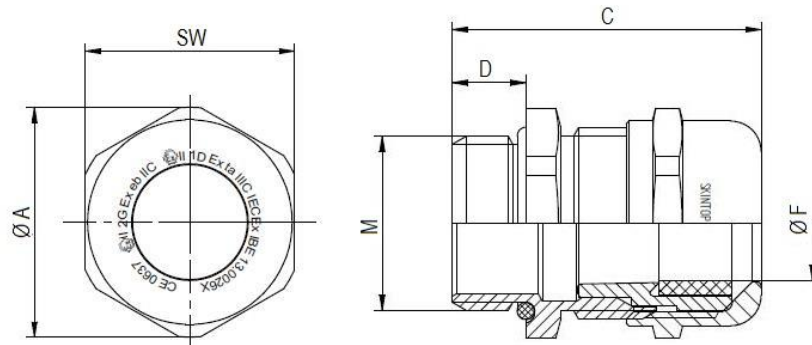

SKINTOP® MS-M ATEX

M	SW [mm]	Ø A [mm]	C max. [mm]	D [mm]	Ø F [mm] Clamping range	O-ring [mm]	Article No.
M12x1,5	16	17,6	26,5	6,5	3-7	9x2	53112700
M16x1,5	20	22,0	33,0	7,0	4,5-10	13x2	53112710
M20x1,5	24	26,4	37,0	8,0	7-13	17x2	53112720
M25x1,5	29	31,9	38,5	8,0	9-17	22x2	53112730
M32x1,5	36	39,6	45,5	9,0	11-21	28x2	53112740
M40x1,5	45	49,5	48,0	9,0	19-28	36x2	53112750
M50x1,5	54	59,0	55,5	10,0	26-35	46x2	53112760
M63x1,5	67	73,5	67,0	15,0	34-45	57x2	53112770
M63x1,5 plus	75	83,9	65,5	15,0	44-55	57x2	53112779

SKINTOP® MS-M XL ATEX

M	SW [mm]	Ø A [mm]	C max. [mm]	D [mm]	Ø F [mm] Clamping range	O-ring [mm]	Article No.
M12x1,5	16	17,6	32,0	12	3-7	9x2	53112800
M16x1,5	20	22,0	38,0	12	4,5-10	13x2	53112810
M20x1,5	24	26,4	41,0	12	7-13	17x2	53112820
M25x1,5	29	31,9	42,5	12	9-17	22x2	53112830
M32x1,5	36	39,6	51,5	15	11-21	28x2	53112840
M40x1,5	45	49,5	54,0	15	19-28	36x2	53112850
M50x1,5	54	59,0	60,5	15	26-35	46x2	53112860

SKINTOP® MSR-M ATEX

M	SW [mm]	Ø A [mm]	C max. [mm]	D [mm]	Ø F [mm] Clamping range	O-ring [mm]	Article No.
M12x1,5	16	17,6	26,5	6,5	2-5	9x2	53112705
M16x1,5	20	22,0	33,0	7,0	4-7	13x2	53112715
M20x1,5	24	26,4	37,0	8,0	5-10	17x2	53112725
M25x1,5	29	31,9	38,5	8,0	6-13	22x2	53112735
M32x1,5	36	39,6	45,5	9,0	7-15	28x2	53112745
M40x1,5	45	49,5	48,0	9,0	16-23	36x2	53112755
M50x1,5	54	59,0	55,5	10,0	19-29	46x2	53112765
M63x1,5	67	73,5	67,0	15,0	32-39	57x2	53112775

For more information please see our current catalogue. Please do not hesitate to contact our laboratory if there are any questions regarding resistance against aggressive agents and special oil.

Creator: VACH1 /PDP Released: DAMU1/PDP	Document: DB53112700EN Version: 15	Page 2 of 2
--	---------------------------------------	-------------