

6220 0421	DATA SHEET
Valid from: 17.05.2018	Cable Trolley C-Rail (C30 / C40)

The Cable Trolley System is designed for C-Rail (C30 and C40) and is available as flat- and round cable system
The fastening components are suitable for both systems.

Material:

Metal Parts	Steel, galvanized
Clamps	Polyamide 6

Technical features

Temperature range	-40°C up to +120°C
Max. Load	C30: 20kg / Cable Trolley C40: 32kg / Cable Trolley

Additional product data:

ETIM 5.0 Class-ID: EC002935
ETIM 5.0 Class-Description: Accessories for Cable Trolley Systems





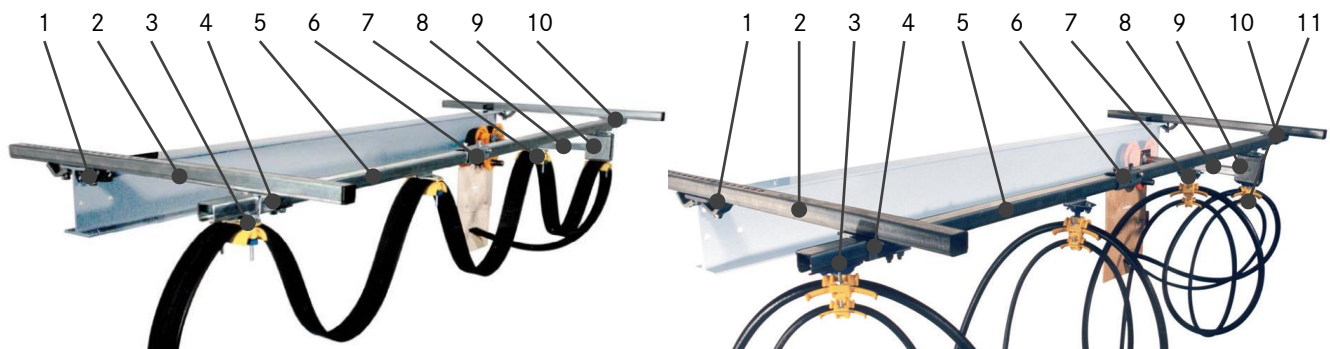

Notes:

- The bending radius corresponds to a permanent installation.
- Cable Trolleys with the addition „b“ are suitable for cables with higher bending radius.

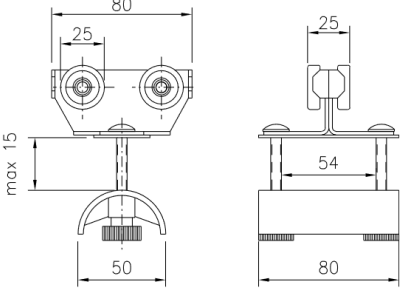
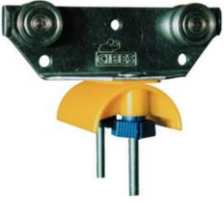
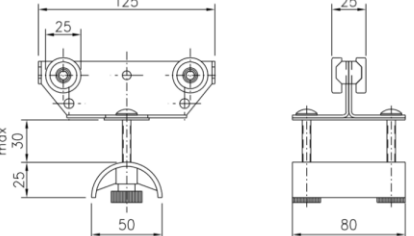

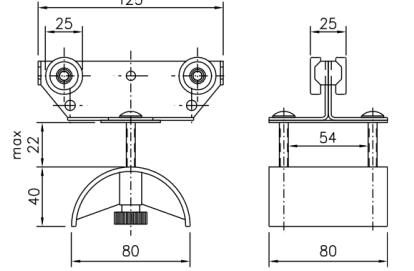

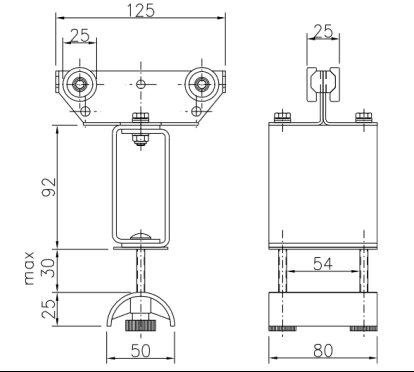

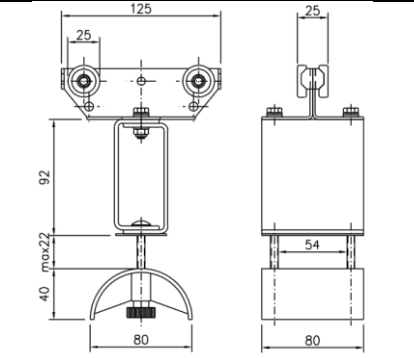

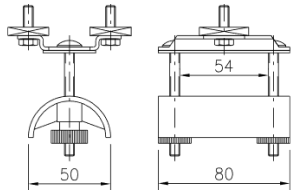

1. Girder clips
2. Support arm
3. End clamp
4. Support bracket
5. C-rail
6. Track coupler
7. Cable trolley
8. Towing arm
9. Towing trolley
10. End stop
11. Cable clamp round

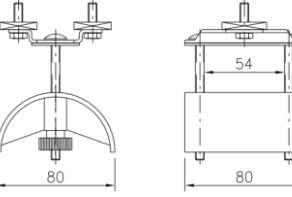
6220 0421	DATA SHEET
Valid from: 17.05.2018	Cable Trolley C-Rail (C30 / C40)

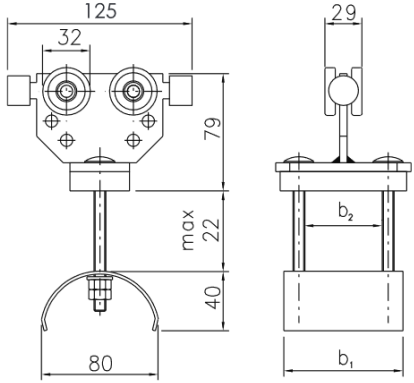
Description	Max. Cable measure mm	Measures mm	Weight kg	Image	Drawing
Cable Trolley Flat Cable C30-Rail					
Cable trolley flat C30 15x54 Part No. 62200421	15 x 54	L = 80 D = 50 B1 = 80 B2 = 54	0,28		
Cable trolley flat C30 30x54 Part No. 62200442	30 x 54	L = 125 D = 50 B1 = 80 B2 = 54	0,36		
Cable trolley flat C30 22x54 Part No. 62200477	22 x 54	L = 125 D = 80 B1 = 80 B2 = 54	0,39		
Towing trolley flat C30 30x54 Part No. 62200420	30 x 54	L = 125 D = 50 B1 = 80 B2 = 54	0,6		
Towing trolley flat C30 22x54 b Part No. 62200482	22 x 54	L = 125 D = 80 B1 = 80 B2 = 54	0,65		

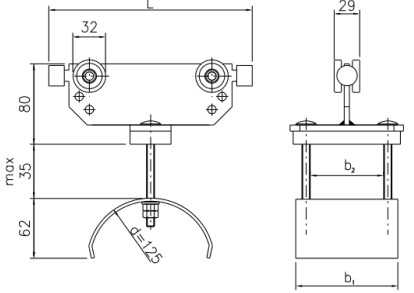

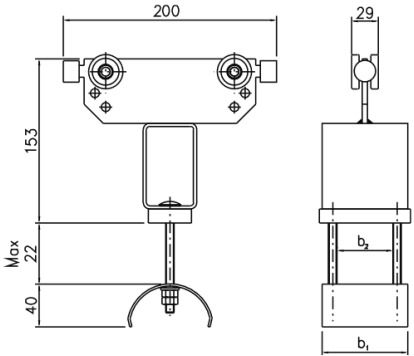



6220 0421	DATA SHEET
Valid from: 17.05.2018	Cable Trolley C-Rail (C30 / C40)

Description	Max. Cable measure mm	Measures mm	Weight kg	Image	Drawing
Part No. End clamp flat C30 30x54 Part No. 62200422	30 x 54	D = 50 B1 = 80 B2 = 54	0,20		
Part No. End clamp flat C30 22x54 b Part No. 62200483	22 x 54	D = 80 B1 = 80 B2 = 54	0,22		
Cable Trolley Flat Cable C40-Rail					
Part No. Cable trolley flat C40 22x52 Part No. 62200464	22 x 52	L = 125 D = 80 B1 = 80 B2 = 52	0,80		
Part No. Cable trolley flat C40 22x72 Part No. 62200479	22 x 72	L = 125 D = 80 B1 = 100 B2 = 72	0,85		
Part No. Cable trolley flat C40 22x97 Part No. 62200419	22 x 97	L = 125 D = 80 B1 = 125 B2 = 97	0,95		
Part No. Cable trolley flat C40 22x132 Part No. 62200480	22 x 132	L = 125 D = 80 B1 = 160 B2 = 132	1,10		
Part No. Cable trolley flat C40 35x72 Part No. 62200446	35 x 72	L = 200 D = 125 B1 = 100 B2 = 72	1,05		
Part No. Cable trolley flat C40 35x97 Part No. 62200457	35 x 97	L = 200 D = 125 B1 = 125 B2 = 97	1,15		
Part No. Cable trolley flat C40 35x132 Part No. 62204505	35 x 132	L = 200 D = 125 B1 = 160 B2 = 132	1,29		
Part No. Towing trolley flat C40 22x52 Part No. 62200465	22 x 52	L = 200 D = 80 B1 = 80 B2 = 52	1,20		
Part No. Towing trolley flat C40 22x72 Part No. 62200488	22 x 72	L = 200 D = 80 B1 = 100 B2 = 72	1,65		
Part No. Towing trolley flat C40 22x97 Part No. 62200418	22 x 97	L = 200 D = 80 B1 = 125 B2 = 97	1,85		
Part No. Towing trolley flat C40 22x132 Part No. 62200489	22 x 132	L = 200 D = 80 B1 = 160 B2 = 132	2,10		

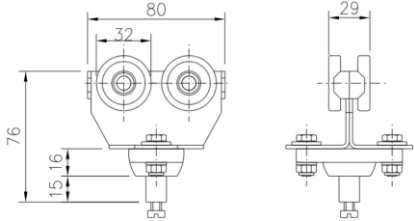

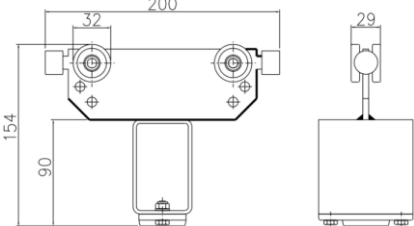

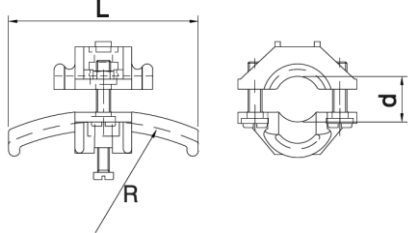

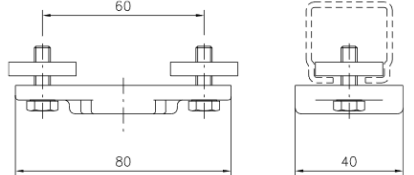

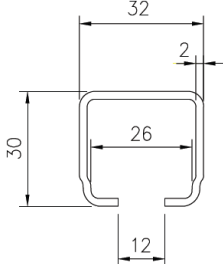

6220 0421	DATA SHEET
Valid from: 17.05.2018	Cable Trolley C-Rail (C30 / C40)

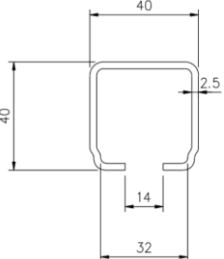
Description	Max. Cable measure mm	Measures mm	Weight kg	Image	Drawing
Towing trolley flat C40 35x72 Part No. 62200447	35 x 72	L = 200 D = 125 B1 = 100 B2 = 72	1,65		
Towing trolley flat C40 35x97 Part No. 62200458	35 x 97	L = 200 D = 125 B1 = 125 B2 = 97	1,85		
Towing trolley flat C40 35x132 Part No. 62200466	35 x 132	L = 200 D = 125 B1 = 160 B2 = 132	2,10		
End clamp flat C40 22x52 Part No. 62200484	22 x 52	L = 111 D = 80 B1 = 80 B2 = 52	0,65		
End clamp flat C40 22x72 Part No. 62200485	22 x 72	L = 111 D = 80 B1 = 100 B2 = 72	0,70		
End clamp flat C40 22x97 Part No. 62200417	22 x 97	L = 111 D = 80 B1 = 125 B2 = 97	0,80		
End clamp flat C40 22x132 Part No. 62200486	22 x 132	L = 111 D = 80 B1 = 160 B2 = 132	0,95		
End clamp flat C40 35x72 Part No. 62200448	35 x 72	L = 171 D = 125 B1 = 100 B2 = 72	0,70		
End clamp flat C40 35x97 Part No. 62200459	35 x 97	L = 171 D = 125 B1 = 125 B2 = 97	0,80		
End clamp flat C40 35x132 Part No. 62204504	35 x 132	L = 171 D = 125 B1 = 160 B2 = 132	0,90		
Cable Trolley Round Cable C30-Rail					
Cable trolley round C30 Part No. 62200434		L = 80	0,26		
Towing trolley round C30 Part No. 62200435		L = 125	0,57		

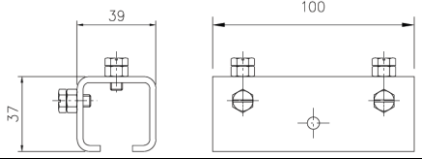
6220 0421	DATA SHEET
Valid from: 17.05.2018	Cable Trolley C-Rail (C30 / C40)

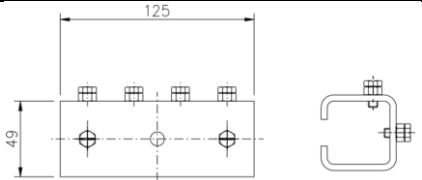
Description	Max. Cable measure mm	Measures mm	Weight kg	Image	Drawing
Cable Trolley Round Cable C40-Rail					
Cable trolley round C40 Part No. 62200478		L = 80			
Towing trolley round C40 Part No. 62200481		L = 200			
Cable Clamp Round Cable C30/C40-Rail					
Cable clamp round 10-16mm Part No. 62200437	10 - 16	R = 80 L = 70	0,04		
Cable clamp round 17-25mm Part No. 62200438	17 - 25	R = 125 L = 100	0,06		
Cable clamp round 26-36mm Part No. 62200439	26 - 36	R = 160 L = 140	0,12		
Cable clamp round Part No. 62200436			0,09		

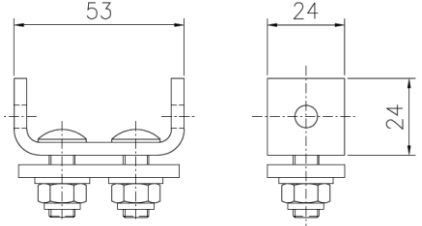
6220 0421	DATA SHEET
Valid from: 17.05.2018	Cable Trolley C-Rail (C30 / C40)

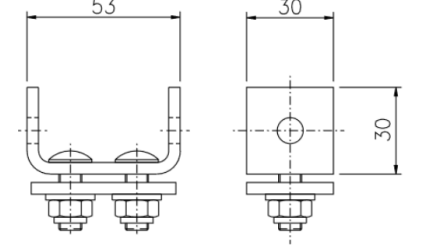
Description	Measures	Weight	Image	Drawing
Part No.	mm	kg		
Attachments Cable Trolleys Round- and Flat Cable				
C-Rail 6m C30 Part No. 62200440	L = 6000	9,3		
C-Rail 6m C40 Part No. 62200444	L = 6000	15,0		
Track coupler C30 Part No. 62200424		0,28		
Track coupler C40 Part No. 62200445		0,61		
End stop C30 Part No. 62200425		0,13		
End stop C40 Part No. 62200449		0,16		
Support bracket with square nuts C30 Part No. 62200427		0,24	